

High Intensity LED Stroboscope Digital Tachometer **DT-361/365**

Instruction manual

Be sure to read before use.

Before use, please carefully read these safety precautions as well as instructions, and follow them for proper use.

Safety Requirements

Be sure to observe

Before operation, maintenance and inspection, please carefully read this instruction manual and follow it for proper use. Please carefully read all information related to this unit's safety precautions before use.

This instruction manual provides two grades of safety warnings: Danger and Caution. Each of them is an important description related to safety. Be sure to follow them.



DANGER

This indicates the possibility of fire, severe injury and even death if a user disregards the instruction and operates the unit improperly.



CAUTION

This indicates a potential situation that could produce a minor injury or damage to material if it is improperly handled. However, depending on the circumstances, there could be a possibility that it may cause more serious results. Be sure to follow them.

Protection categories are explained and separated by the following symbols



Not allowed -prohibited



Mandatory Must follow

⚠ DANGER



Do not use this product in an atmosphere with risk of fire and/or explosion.
Failure to follow this could result in fire.



Do not look directly at the light emitting section.
Failure to follow this could result in injury to the eyes.

⚠ CAUTION



Do not apply strong impact to the unit, or drop it.
Failure to follow this could result in abnormal operation.



Do not use and/or store the unit in the following places.

- Where water may come in contact
- Where direct sunlight come in contact
- Where high humidity environment may be present
- Where dust, dirt, salt, and/or iron may be present
- Where oil, water, and/or chemicals come in contact
- Where a fire or explosion may exist or occur.



Never disassemble, repair, and remodel the unit.
Failure to follow this could result in injury due to abnormal operation.



Use the unit within the proper operating temperature range (32 - 95F).
Failure to follow this could result in malfunction.



Wipe clean the unit with a soft dry cloth if it gets dirty. Or immerse a cloth in water diluted neutral detergent, wring it, and wipe clean the unit with it. Do not use any volatile chemicals, such as benzene, thinner, or alcohol.



Use the unit within the proper operating humidity range (35 - 85%RH). (No condensation)
Failure to follow this could result in malfunction.



Since continuously emitting light for long time causes the unit's housing to be very hot, fix the LED strobe using a tripod, etc. and use the unit (avoid direct skin contact with the unit, such as holding it by hand).
Failure to follow this could result in mild burns.

- Contents -

| | | |
|---------|--|----|
| 1 | Overview | 4 |
| 2 | Before use | 4 |
| 2.1 | Checking accessories | 4 |
| 2.2 | Peel off the protection sheet | 5 |
| 2.3 | Charging (only for DT-365) | 5 |
| 2.3.1 | Charging method | 5 |
| 2.3.2 | Indication of low battery voltage | 6 |
| 2.3.3 | Battery replacement | 6 |
| 3 | Part names and functions | 7 |
| 3.1 | Main unit | 7 |
| 3.2 | Operation section | 7 |
| 3.3 | Display | 8 |
| 3.3.1 | Part names | 8 |
| 3.3.2 | Number display | 8 |
| 3.3.3 | Unit display | 8 |
| 3.3.4 | Emission setting display | 8 |
| 3.3.5 | Mode display | 8 |
| 3.3.6 | Memory number display | 8 |
| 3.3.7 | Charging lamp (only for DT-365) | 8 |
| 4 | Functions and operations | 9 |
| 4.1 | Power ON/OFF | 9 |
| 4.2 | Emission setting | 10 |
| 4.3 | Internal oscillation emission | 11 |
| 4.3.1 | Display of internal oscillation emission | 11 |
| 4.3.2 | Switching the modes | 11 |
| 4.3.3 | Switching the unit display | 11 |
| 4.3.4 | Emission count mode | 12 |
| 4.3.4.1 | Emission count setting | 12 |
| 4.3.4.2 | Changing the emission count (frequency) to double or half | 13 |
| 4.3.5 | Emission duration mod | 14 |
| 4.3.6 | Phase mode | 15 |
| 4.4 | External synchronous emission | 16 |
| 4.4.1 | Emission count mode | 16 |
| 4.4.2 | Emission duration mode | 17 |
| 4.4.3 | Phase mode | 18 |
| 4.4.3.1 | How to set the delay | 19 |
| 4.5 | Memory function | 20 |
| 4.5.1 | Saving each setting value | 20 |
| 4.5.1.1 | Saving on internal oscillation emission | 21 |
| 4.5.1.2 | Saving on external synchronous emission | 22 |
| 4.5.1.3 | Saving the setting value when the power is OFF | 22 |
| 4.5.2 | Reading out each setting value | 23 |
| 4.5.2.1 | Reading out on internal oscillation emission | 23 |
| 4.5.2.2 | Reading out on external synchronous emission | 24 |
| 4.6 | Function mode | 25 |
| 4.6.1 | Moving to the function mode | 25 |
| 4.6.2 | Measurement range setting (Function mode 1) | 26 |
| 4.6.3 | Trigger edge setting (Function mode 2) | 27 |
| 4.6.4 | Auto emission stop time setting (Function mode 3) | 29 |
| 4.6.5 | Input signal setting (Function mode 4) | 30 |
| 4.7 | External I/O connector | 31 |
| 4.7.1 | Specifications for external I/O connector and pin assignment | 31 |
| 4.7.2 | External pulse input | 32 |
| 4.7.3 | External trigger pulse output | 32 |
| 5 | Specifications | 33 |
| 6 | External dimensions | 34 |
| 7 | Trouble shooting | 35 |

1 Overview

A stroboscope tachometer is a measurement instrument to measure the speed (cycle) of rotating objects that rotate at a constant speed, or moving objects that repeatedly operate at a constant cycle. When the rotation (motion) cycle matches the flash cycle while the strobe flash is periodically applied on a rotating or moving object, the rotating (moving) object image appears to stand still. This stroboscope tachometer is non-contact and can be used to read the flash frequency when such a still image appears. Also, a stroboscope can be used to make images of rotating or moving objects stand still or slightly move in order to observe their appearances.





Main features

- Wide-range measurement of 60 to 120,000 fpm
⇒ **Refer to 4.3.4.1 Emission count setting for details**
- Simply pressing the x2 or ÷2 key can change the emission count (frequency) to double or half respectively
⇒ **Refer to 4.3.4.2 Changing the emission count (frequency) to double or half for details**
- The emission time (duty) can be changed by 0.1° within the range between 0.1% to 3.6% / 360°
⇒ **Refer to 4.3.5 flash duration mode**
- The emission timing (phase) can be adjusted
⇒ **Refer to 4.3.6 Phase mode for details**
- The external I/O function is implemented which enables emission in synchronization with the external pulse, and enables the pulse signal in synchronization with the strobe emission to be output.
⇒ **Refer to 4.4 External synchronous emission for details**

2 Before use

2.1 Checking accessories

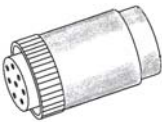
Check that the three items in the table below are supplied.

| | DT-361 | DT-365 |
|--------------------|---|--|
| Main unit | DT-361 x 1  | DT-365 x 1  |
| Connector | External signal I/O connector (8 pin) x 1 RM15WTP-8S(7)  | Dedicated AC adapter x 1  |
| Instruction manual | This document x 1 | This document x 1 |

2.2 Peel off the protection sheet

Peel off the protection sheet on the operation section.

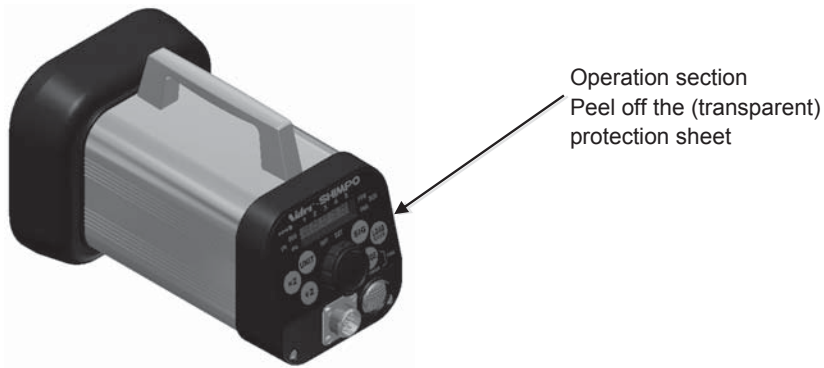

2.3 Charging (only for DT-365)

Be sure to charge the battery before initial use. Before charging, be sure to check that the power is turned OFF.

2.3.1 Charging method

Turn the power OFF and connect the supplied AC adapter's connector to the main unit. Next insert the AC adapter's AC plug into an outlet. The battery lamp lights up and charging starts.

Charging is complete in approximately 2.5 hours. Then the battery charging lamp turns off.

* Be sure to use only the supplied AC adapter.

When the power is turned ON with the supplied AC adapter connected, charging ends and operation starts.

* Note that operation and charging cannot be performed simultaneously.



Note 1) Since the battery current is automatically shut off when charging is complete, there is no need to worry about overcharging.

Note 2) When the power is turned ON during charging, charging is canceled and emission starts. When the unit uses the AC adapter as its power source, it is not charged.

Note 3) To extend battery life and charging capacity, it is recommended to deplete the battery fully before charging. (LLLLLL is indicated on the number display)

Note 4) If the unit is charged immediately after long periods of usage at a high ambient temperature, the temperature rise protection circuit will turn on and the charging lamp may not light up. In that case, disconnect the AC adapter and let the unit cool. When the product temperature is decreased, connect the AC adapter again to start charging.

Note 5) Never charge the unit under the following conditions.

• Using another AC adapter than supplied.

• Charging near flammable materials

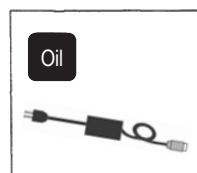
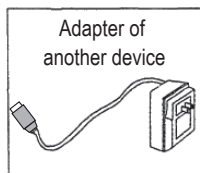

2.3.2 Indication of low battery voltage

If the remaining battery power drops to near zero, the number display alternates between the process setting and LLLLLL. However, operation can be performed even when the battery is in this low condition.

If the remaining battery decreases further, the number display indicates only LLLLLL, which then stops operation. Press the power switch and shut off the power immediately.

In either case, charge the unit according to the procedure in **2.3.1 Charging method**.

•Indication of low battery voltage

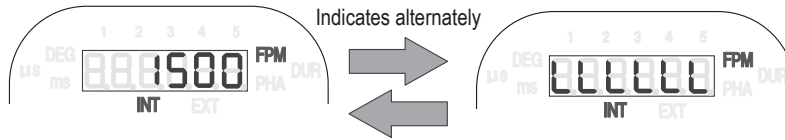

•Indication of stopped operation



2.3.3 Battery replacement

If the fully charged battery continually decreases, please replace it with the specified replacement battery. Please contact your local dealer for details.

1. Remove 4 screws located on the bottom of DT-365 and take out the battery assembly.
2. Remove the screws on the connector and the battery supporter and replace with the new battery.
3. Fix the new battery with the screws and connect the connector.
4. Install the new battery assembly to DT-365.

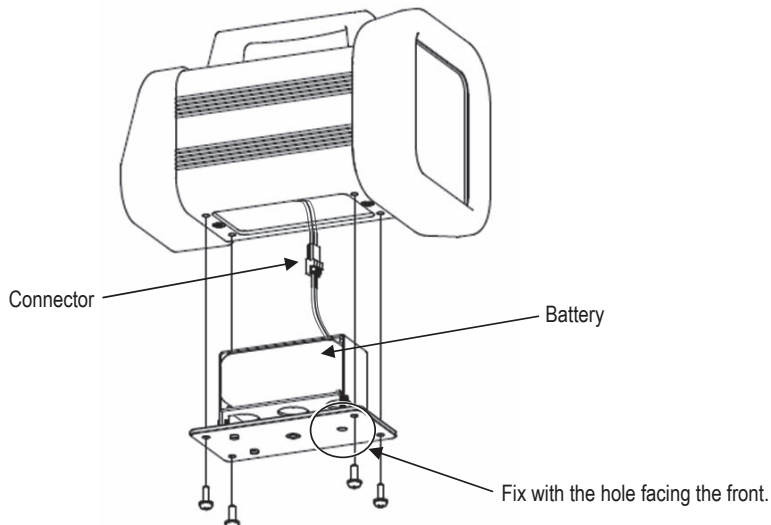

3 Part names and functions

3.1 Main unit

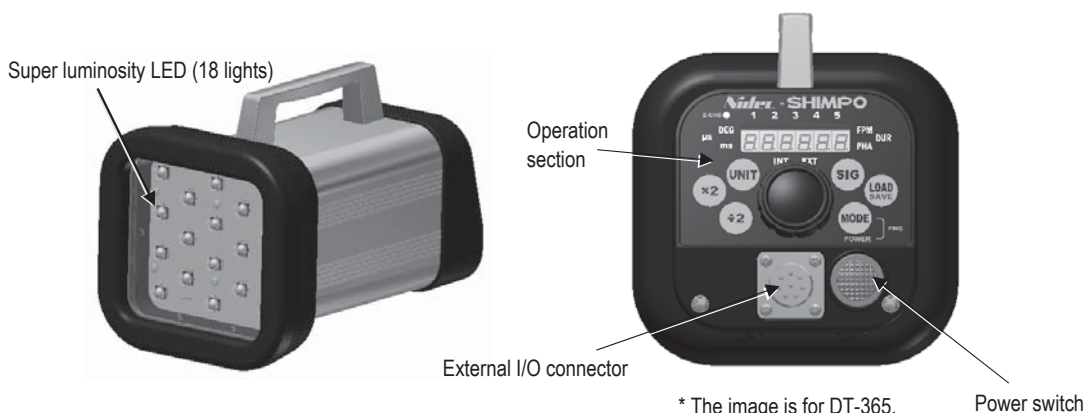

3.2 Operation section



* The image is for DT-365.

| No. | Name | Function description |
|-----|-----------------|---|
| ① | Power switch | Turns the power ON/OFF. |
| ② | Dial | Used to change the emission frequency or emission duration. |
| ③ | MODE key | Each press of this key switches the number display in the following order: Emission frequency (FPM), Emission duration, Emission delay duration (PHA), Emission frequency (FPM)... |
| ④ | LOAD (SAVE) key | Reads the saved setting value. Also, saves the current setting value by pressing and holding it. |
| ⑤ | SIG key | Switches the internal oscillation emission and external synchronous emission. |
| ⑥ | UNIT key | Switches to indicate the emission time when the emission duration is indicated. When the delay duration is indicated, each press of this key switches indication of the delay time and angle. |
| ⑦ | x2 key | Each press of this key during on internal oscillation emission alters allows the performance of emission by double the current set emission count (frequency). |
| ⑧ | ÷2 key | Each press of this key during on internal operation mode drops the current emission by half the count (frequency). |

3.3 Display

3.3.1 Part names

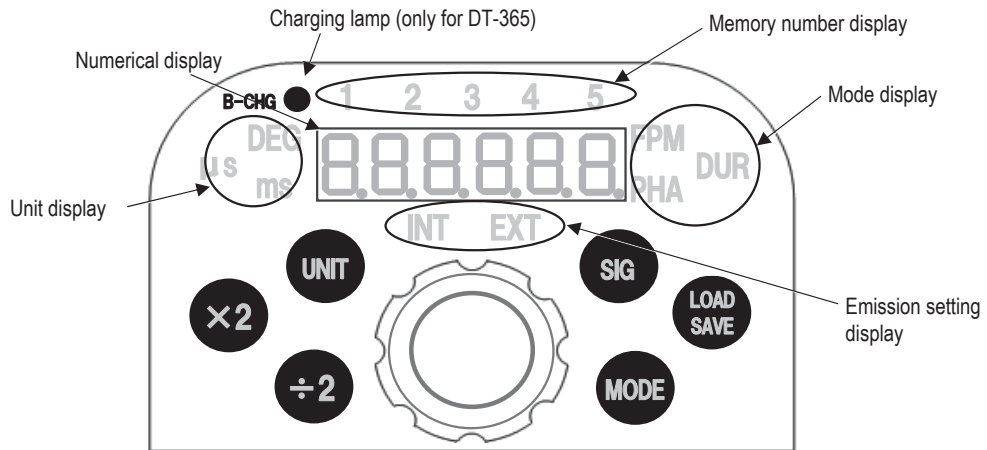

3.3.2 Number display

- Indicates the setting value of the emission count (frequency) in internal oscillation emission mode.
 - Indicates the external signal frequency in external synchronous emission mode.
 - Each setting value is indicated in the function setting mode.
- * For details about the function setting mode, refer to **4.6 Function mode**.

3.3.3 Unit display

Indicates the unit of the value on the number display.

| | | |
|---------------------------|--------------------------|------------|
| DEG | μs | ms |
| Emission duration (angle) | Emission duration (time) | Delay time |
| Delay duration (phase) | | |

3.3.4 Emission setting display

Indicates the emission setting.

| | |
|-------------------------------|-------------------------------|
| INT | EXT |
| Internal oscillation emission | External synchronous emission |

3.3.5 Mode display

Indicates the mode on the number display.

| | | |
|---------------------|------------------------|------------|
| FPM | DUR | PHA |
| Emission count mode | Emission duration mode | Phase mode |

3.3.6 Memory number display

Indicates the memory number on the number display.

When all the numbers go off the memory number 0 (free mode) is assigned and the previous setting value is indicated.

3.3.7 Charging lamp (only for DT-365)



Lights up while charging and goes off when charging is complete.

4 Functions and operations

4.1 Power ON/OFF

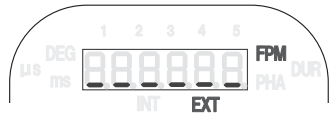

Press the power switch when the power is OFF to turn the power ON.

When the power is turned ON, the model is indicated, followed by internal oscillation emission or external synchronous emission.

| Operation | Display |
|--|---|
| <p>When the power is OFF</p>  <p>Press the power switch</p> | <p>Internal oscillation emission when the power was last OFF</p>  <p>External synchronous emission when the power was last OFF</p>  <p>The screen of internal oscillation emission is indicated and emission starts.</p> <p>The screen of external synchronous emission is indicated and the unit enters the standby mode for the external signal.</p> |



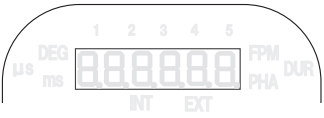

* When DT-365 is used, the indication may go off immediately after the power is turned ON. In that case, charge the unit because the remaining battery level is low. For details about charging, refer to **2.3 Charging**.

Press the power switch when the power is ON to turn the power OFF, then the indication goes off.

| Operation | Display |
|---|---|
| <p>When the power is ON</p>  <p>Press the power switch</p> |    <p>Indicated letters go off.</p> |

* When the power is turned ON, the following indication may be displayed.

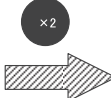
The following is the error message showing EEPROM read failure. Press the x2 key to return to the normal emission screen from the error message display.

| Operation | Display |
|---|---|
|  <p>Press the x2 key</p> |  <p>Error display EEPROM read failure</p>   <p>Returns to the normal setting screen</p> |

4.2 Emission setting

Each press of the SIG key switches between internal oscillation emission and external synchronous emission.

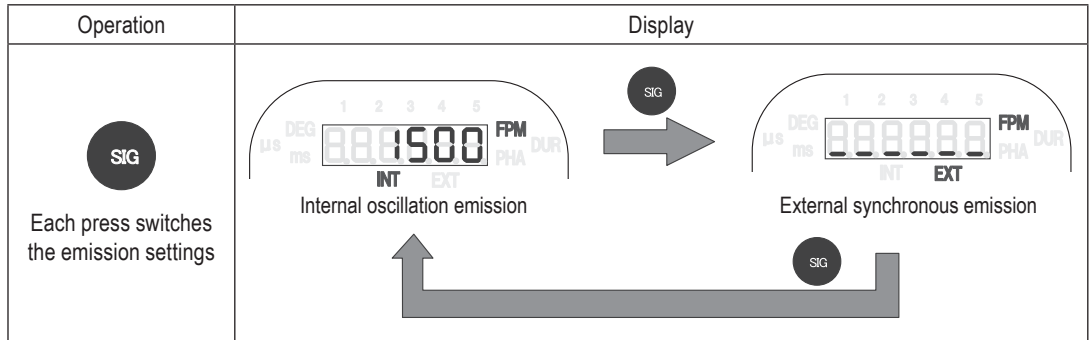

4.3 Internal oscillation emission

4.3.1 Display of internal oscillation emission

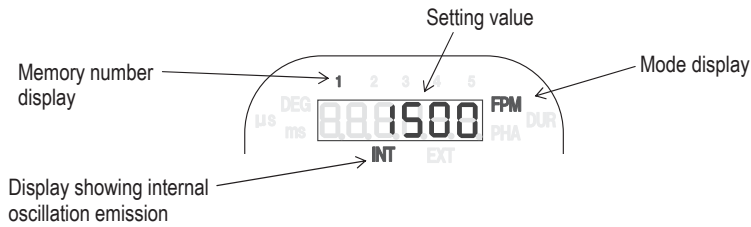

4.3.2 Switching the modes

Each press of MODE key switches the setting display value to FPM (emission count mode), DUR (emission duration mode), and PHA (phase mode).

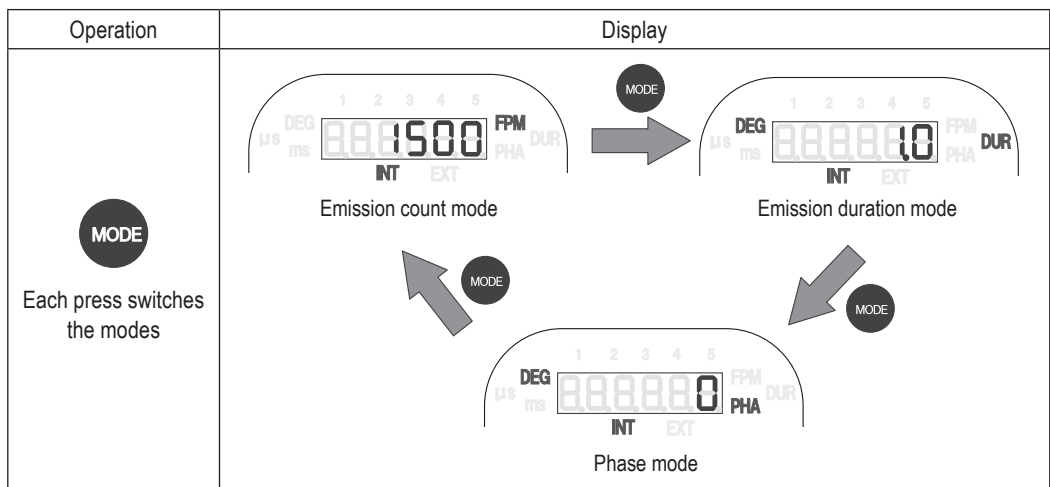

4.3.3 Switching the unit display

While the UNIT key is pressed and held in the emission duration mode (DUR), the unit display is switched from [°] to [μs].

Each press of the UNIT key in the phase mode (PHA) switches the unit display from [°] to [ms].

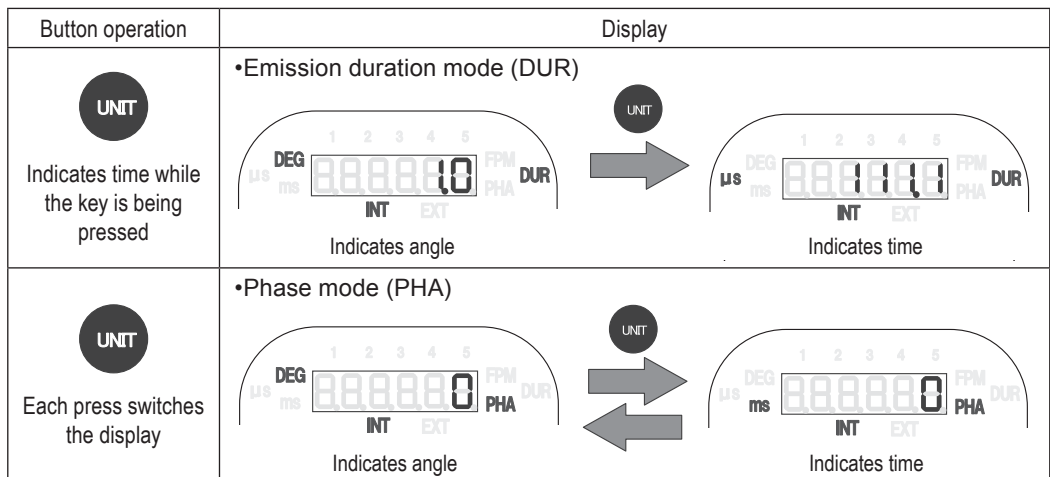

4.3.4 Emission count mode



The emission count (frequency) can be set in the emission count mode (FPM).

4.3.4.1 Emission count setting

Turn the dial to the CW direction to increase the emission count (frequency), and to the CCW direction to decrease it. Turn the dial fast to change the setting value greatly and slowly to change it slightly.

The emission count (frequency) you can set depends on the measurement range. For details about the measurement range, refer to **4.6.2 Measurement range setting**.

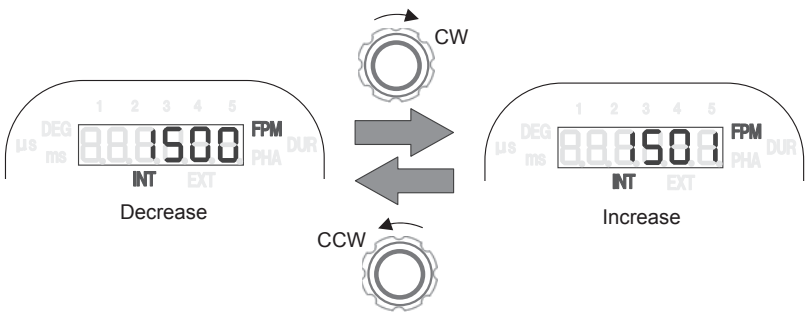
Press the MODE key to switch to the emission duration mode (DUR).

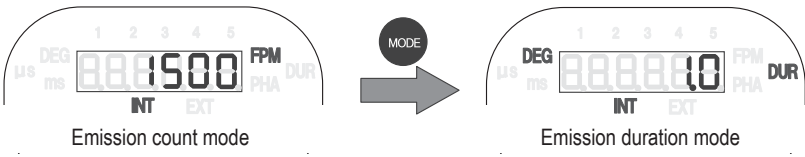
| Operation | Display |
|--|--|
|  <p>Increase/decrease the emission count (frequency)</p> |  <p>CW</p> <p>Decrease</p> <p>Increase</p> <p>CCW</p> |
|  <p>Press the key to switch to the emission duration mode</p> |  <p>Emission count mode</p> <p>Emission duration mode</p> |

4.3.4.2 Changing the emission count (frequency) to double or half

The emission count (frequency) can be changed to double or half of the current setting value using the key operation on internal oscillation emission.

1) To change the emission count (frequency) to double of the current setting value

Each press of the x2 key changes the emission count (frequency) to double of the current setting value on internal oscillation emission.

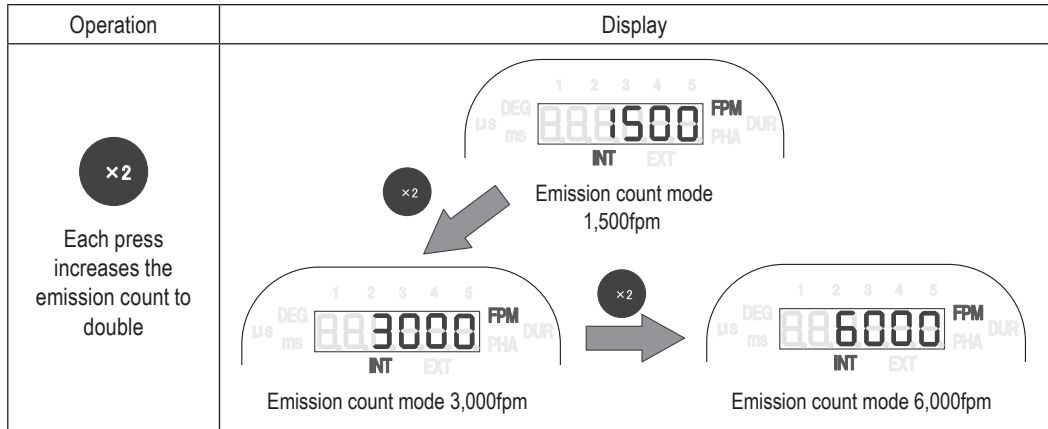

* If the doubled emission count (frequency) goes beyond the value in the measurement range, the key operation will be disabled.

The emission count (frequency) after change provides the value according to the setting display resolution (for details about the setting display resolution, refer to **5 Specifications**). For this reason, after pressing the x2 key and doubling the emission count (frequency), the value may not be returned to the initial value even by pressing the "÷2" key and halving it.

2) To change the emission count (frequency) to half of the current setting value

Each press of the "÷2" key changes the emission count (frequency) to half of the current setting value on internal oscillation emission.

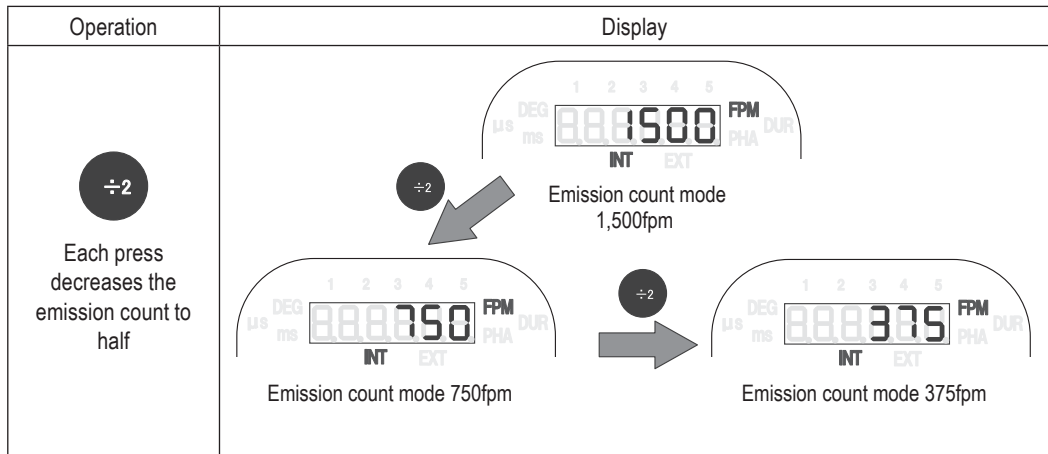

* If the half of the emission count (frequency) goes below the value in the measurement range, the key operation will be disabled.

The emission count (frequency) after change provides the value according to the setting display resolution (for details about the setting display resolution, refer to **5 Specifications**). For this reason, after pressing the ÷2 key and halving the emission count (frequency), the value may not return to the initial value even by pressing the x2 key and doubling it.

4.3.5 Emission duration mode

The emission time (ratio) can be set by 0.1° within the range between $0.1^\circ / 360^\circ$ and $3.6^\circ / 360^\circ$ in the emission duration mode (DUR). The emission time setting value shows the strobe emitting time by angle while a rotating object rotates one revolution (360°).

While the "UNIT" key is being pressed, the value converted from the emission angle to time can be checked.

A longer emission time increases the brightness, but a measured object appears to be moving. Also, a shorter emission time decreases the brightness, but a measured object appears to stand more still.

Adjust the appropriate emission time according to your application and conditions and use the unit. Press the MODE key to switch to the phase mode (PHA).

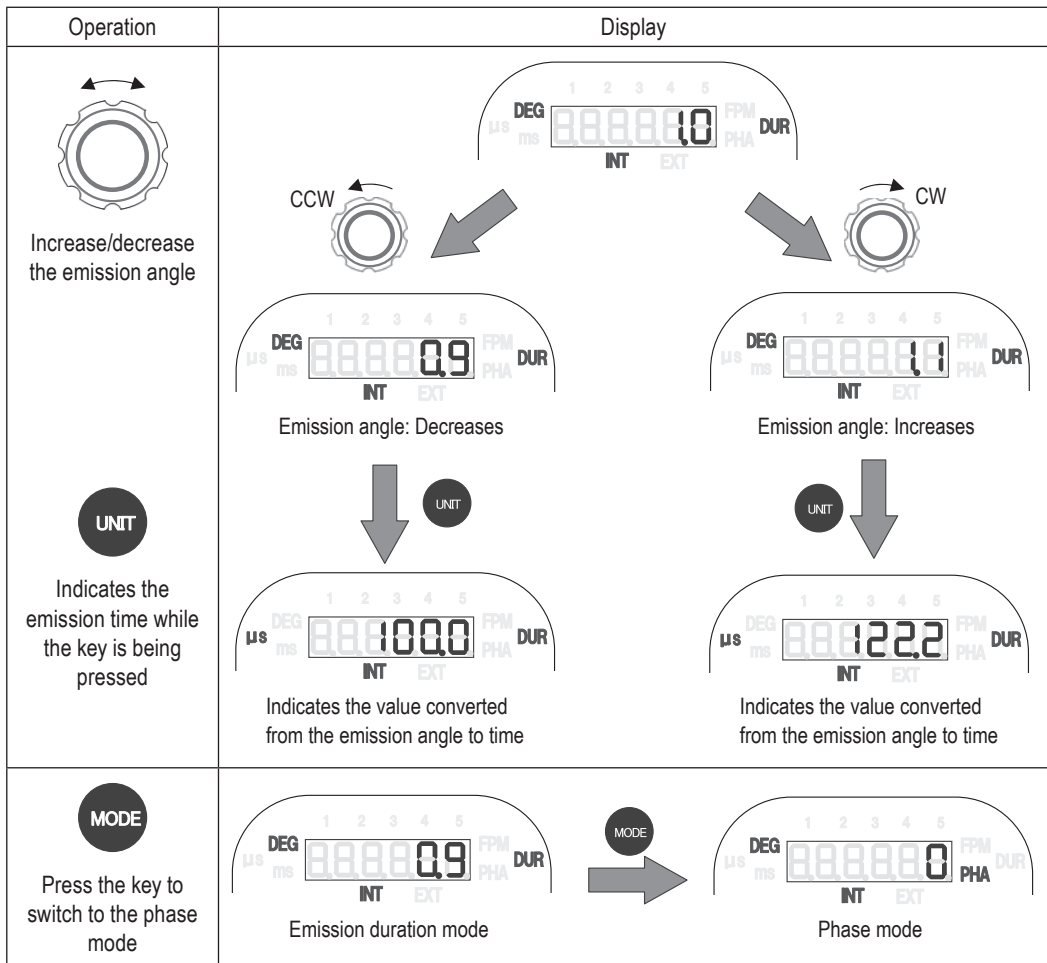

4.3.6 Phase mode











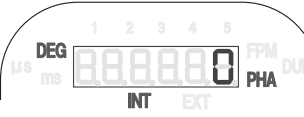

When the rotation (motion) cycle of a measured object matches with the strobe flash cycle, the measured object appears to stand still. To change the angle (position) to make the object stand still, use the phase mode.

The phase can be changed by 0.1° using the dial within the range between 1° and 359° in the phase mode (PHA).

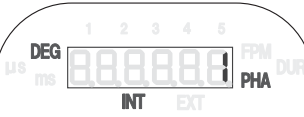
Press the UNIT key to set the phase change by time. The phase can be changed by 1 ms within the range between 0 ms and 999 ms (max.).

When time is used for setting, a longer time duration than the emission cycle cannot be set.

Press the MODE key to switch to the emission count mode (FPM).

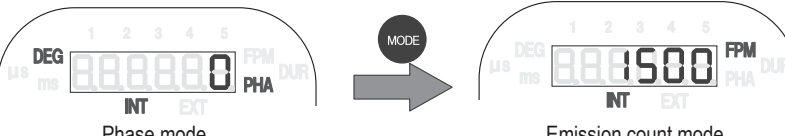
| Operation | Display | |
|--|---|--|
|  <p>Increase/decrease the delay angle</p>  <p>Each press switches the delay time display</p> | <p>Delay angle: Decreases</p>    <p>Delay time: Decreases</p>  | <p>Delay angle: Increases</p>    <p>Delay time: Increases</p>  |
|  <p>Press the key to switch to the emission count mode</p> |   <p>Phase mode Emission count mode</p> | |

4.4 External synchronous emission

External synchronous emission is the function to emit a strobe flash in synchronization with an external pulse.

- To activate external synchronous emission mode, refer to **4.2 Emission setting**.
- You can set which edge of the external pulse triggers the emission, the rising edge or falling edge. Refer to **4.6.3 Trigger edge setting**.
- Timing (delay) from the external pulse entry to strobe flash emission can be optionally set.

4.4.1 Emission count mode

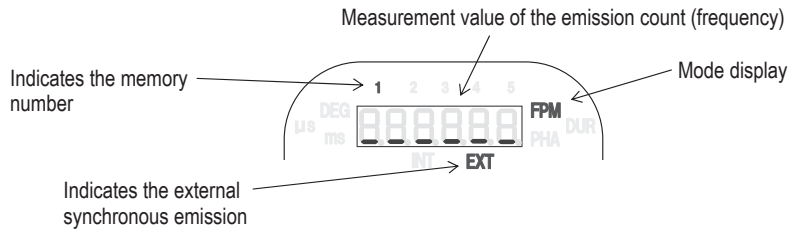

- * The external pulse frequency is measured per cycle and indicated (An averaging procedure is applied every 200 ms to update the measurement value and indicate the latest one.)
- If the external pulse cycle is beyond the specifications range, the following letters are indicated.

[Without the delay angle setting]

Measurable range 40 to 35,000

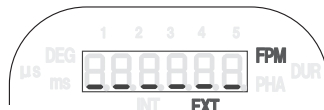

When the external input pulse frequency goes below 40 fpm



When the external input pulse frequency goes beyond 35,000 fpm

[With the delay angle setting]

Measurable range 60 to 10,000



When the external input pulse frequency goes below 60 fpm

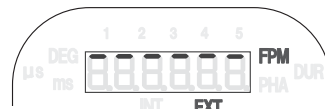

When the external input pulse frequency goes beyond 10,000 fpm

Press the MODE key to switch to the emission duration mode (DUR).

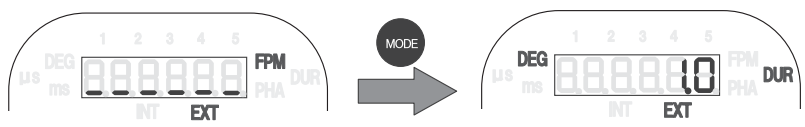
| Operation | Display |
|--|--|
|  Press the key to switch to the emission duration mode |  Emission count mode → Emission duration mode |

4.4.2 Emission duration mode

The emission time (ratio) can be set by 0.1° within the range between 0.1°/ 360° and 3.6°/ 360° in the emission duration mode (DUR). (The emission time setting value shows the strobe emitting time by angle while a rotating object rotates one revolution (360°).)

While the "UNIT" key is being pressed, the value converted from the emission angle to time can be checked.

A longer emission time increases the brightness, but a measured object appears to be moving. Also, a shorter emission time decreases the brightness, but a measured object appears to stand more still.

Adjust the appropriate emission time according to your application and conditions and use the unit. Press the MODE key to switch to the phase mode (PHA).

* When the external synchronous signal has not been entered, [_ _ _ _ _] and the emission time are indicated alternately.



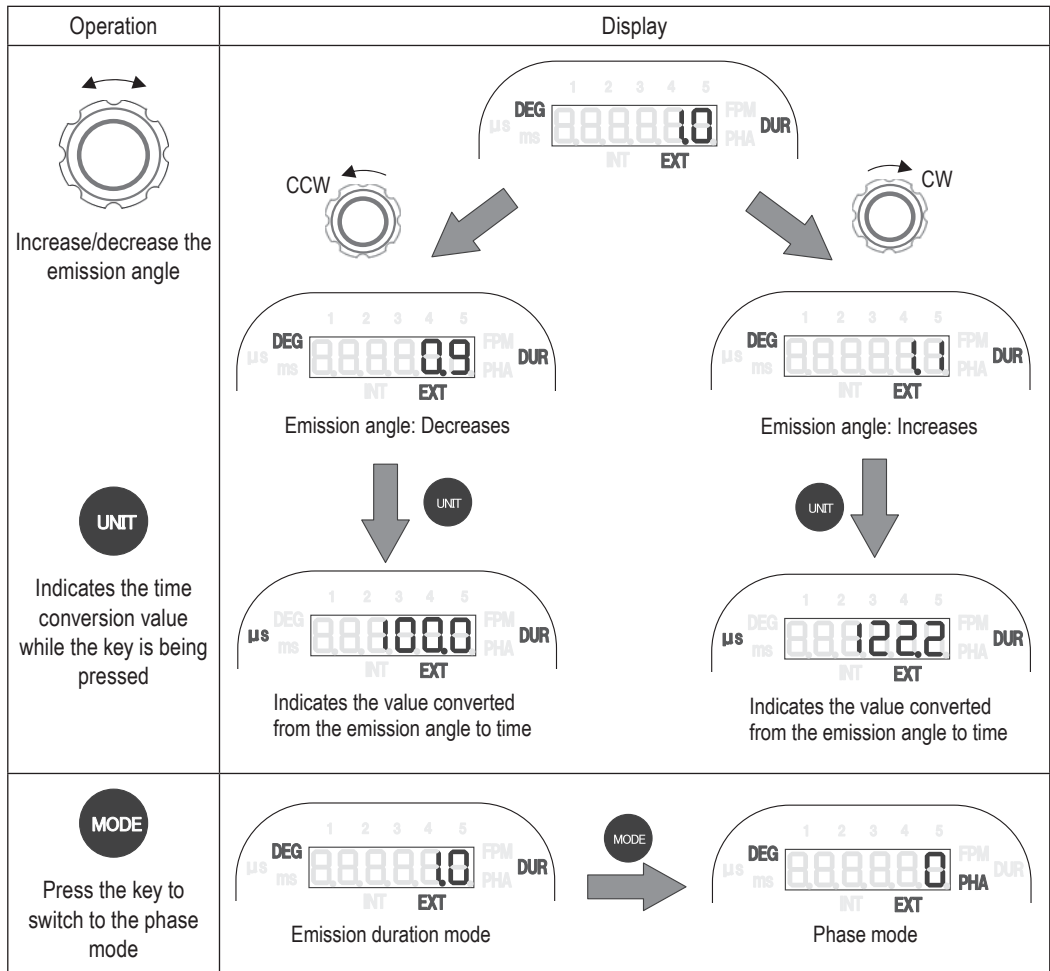

When the external synchronous signal has been entered, only the emission time is indicated.



4.4.3 Phase mode

Delay emission can be set within the input signal range between 60 fpm and 10,000 fpm. In the phase mode (PHA), the delay angle from the external pulse entry to strobe flash emission can be changed by 0.1° using the dial within the range between 1° and 359°. Press the UNIT key to set the phase change by time. The phase can be changed by 1 ms within the range between 0 ms and 999 ms (max.). When time is used for setting, a time longer than the emission cycle cannot be set. Press the MODE key to switch to the emission count mode (FPM).

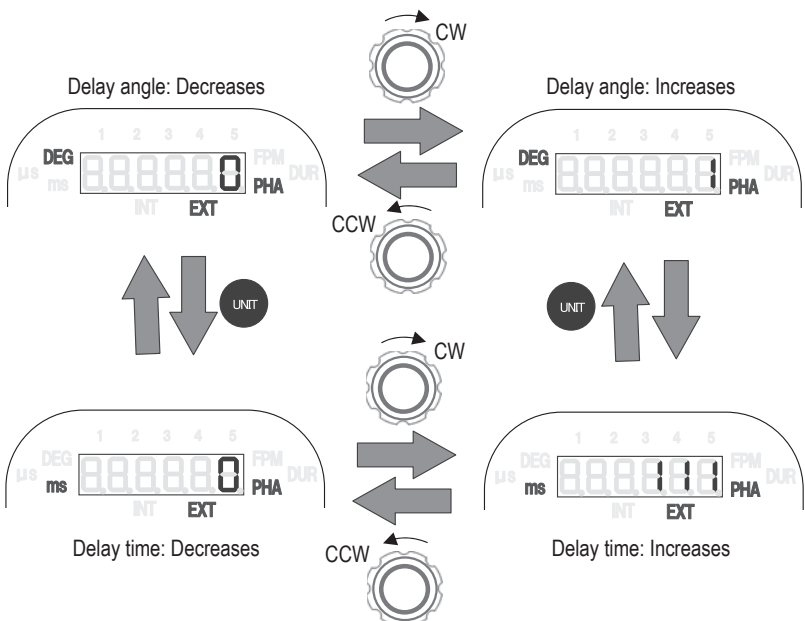
* When the external synchronous signal has not been entered, [_ _ _ _ _] and the delay setting values are indicated alternately. When the external synchronous signal has been entered, only the delay setting value is indicated.

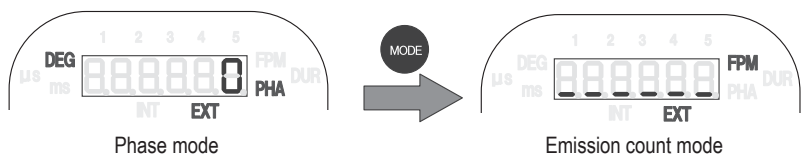
| Operation | Display |
|--|---|
|  <p>Increase/decrease the delay angle</p>  <p>Each press switches the delay time display</p> |  <p>Delay angle: Decreases</p> <p>Delay angle: Increases</p> <p>Delay time: Decreases</p> <p>Delay time: Increases</p> |
|  <p>Press the key to switch to the phase mode</p> |  <p>Phase mode</p> <p>Emission count mode</p> |

4.4.3.1 How to set the delay

The delay angle from the pulse input to emission can be set by 0.1° within the range between 1° and 359° by setting one cycle of the external pulse to 360°. Measure the external pulse frequency per cycle, and calculate the delay angle based on the measured frequency to perform the delay emission. Since a delay of approximately 30 μs always exists for the internal calculation, the actual delay time is calculated as follows:

$$\frac{\text{Delay setting angle}}{360^\circ} \times \text{External pulse cycle} + \text{Approximately } 30 \mu\text{s}$$

[Example 1] When setting the input frequency to 10 Hz (600 fpm), trigger edge to rising, and delay angle to 36°

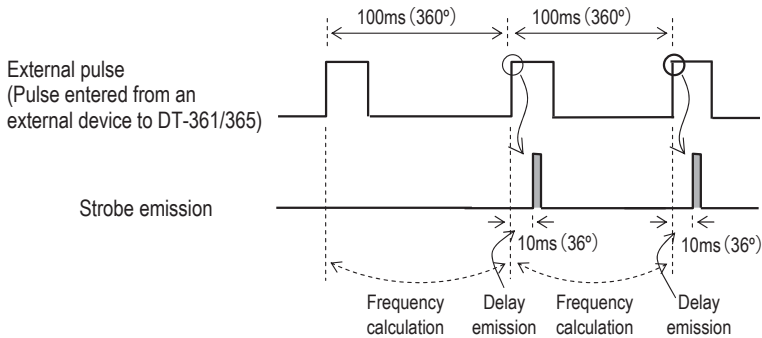

* When the delay unit is set to ms in the above example, the delay time can be set within the time range of less than one cycle input pulse (0 ms to 99 ms).

• Since the delay angle is calculated based on the previously entered pulse cycle, if the external pulse frequency changes, emission cannot be performed at a precise angle. Also, since the external pulse cycle becomes shorter than the previous pulse cycle, if the next pulse is entered before delay angle emission, the delay angle setting will be disabled, and emission is performed simultaneously* with the external pulse.

• When the delay angle is set to 0°, emission is performed simultaneously with the external pulse.

* Since there is a delay caused by the internal calculation process, the strobe actually emits light in approximately 30 μs after the external pulse is entered.

Turn the dial to the right to increase the delay angle setting value. Increasing the setting value from 359° will be 0°.

4.5 Memory function

Each setting value can be saved and read out.

4.5.1 Saving each setting value

This function is used to save each setting value.

There are two types of saving methods, one is to save a parameter by pressing and holding the "LOAD(SAVE)" key, and the other is to save a setting value by turning the power OFF.

The number of data entries that can be set is five on internal oscillation emission and external synchronous emission respectively when saving by the "LOAD(SAVE)" key, and one when saving by power OFF.

●Setting values that can be saved

| Saving method | | Save a parameter using the "LOAD(SAVE)" key | | Save when the power is turned OFF | |
|---|--------------------------|---|-------------------------------|-----------------------------------|-------------------------------|
| | | Internal oscillation emission | External synchronous emission | Internal oscillation emission | External synchronous emission |
| Emission status when the value is saved | | Internal oscillation emission | External synchronous emission | Internal oscillation emission | External synchronous emission |
| Memory number that can be saved | | 1 to 5 | 1 to 5 | - | - |
| Emission mode (INT/EXT) | | x | x | o | o |
| Setting mode (FPM/DUR/PHASE) | | o | o | o | o |
| Internal oscillation emission (INT) | Emission frequency (FPM) | o | x | o | o |
| | Emission duration (DUR) | o | x | o | o |
| | Delay angle (PHASE) | o | x | o | o |
| | Delay time (PHASE) | o | x | o | o |
| External synchronous emission (EXT) | Emission duration (DUR) | x | o | o | o |
| | Delay angle (PHASE) | x | o | o | o |
| | Delay time (PHASE) | x | o | o | o |

4.5.1.1 Saving on internal oscillation emission

Press and hold the “LOAD(SAVE)” key in the Internal oscillation emission mode to save the setting value.

Press and hold the LOAD(SAVE) key to enter the save standby status. SAVE and the memory number in which the setting value is saved are indicated alternately. In this status, a memory number in which the setting value is saved can be changed using the dial operation.

Operate the dial to end alternate lighting. Only a memory number in which the setting value is saved is indicated.

To save, press the “LOAD(SAVE)” key. The setting value is saved in the specified memory number and the display returns to the emission screen.

To cancel saving, press the x2 key. The save standby status ends and the display returns to the emission screen.

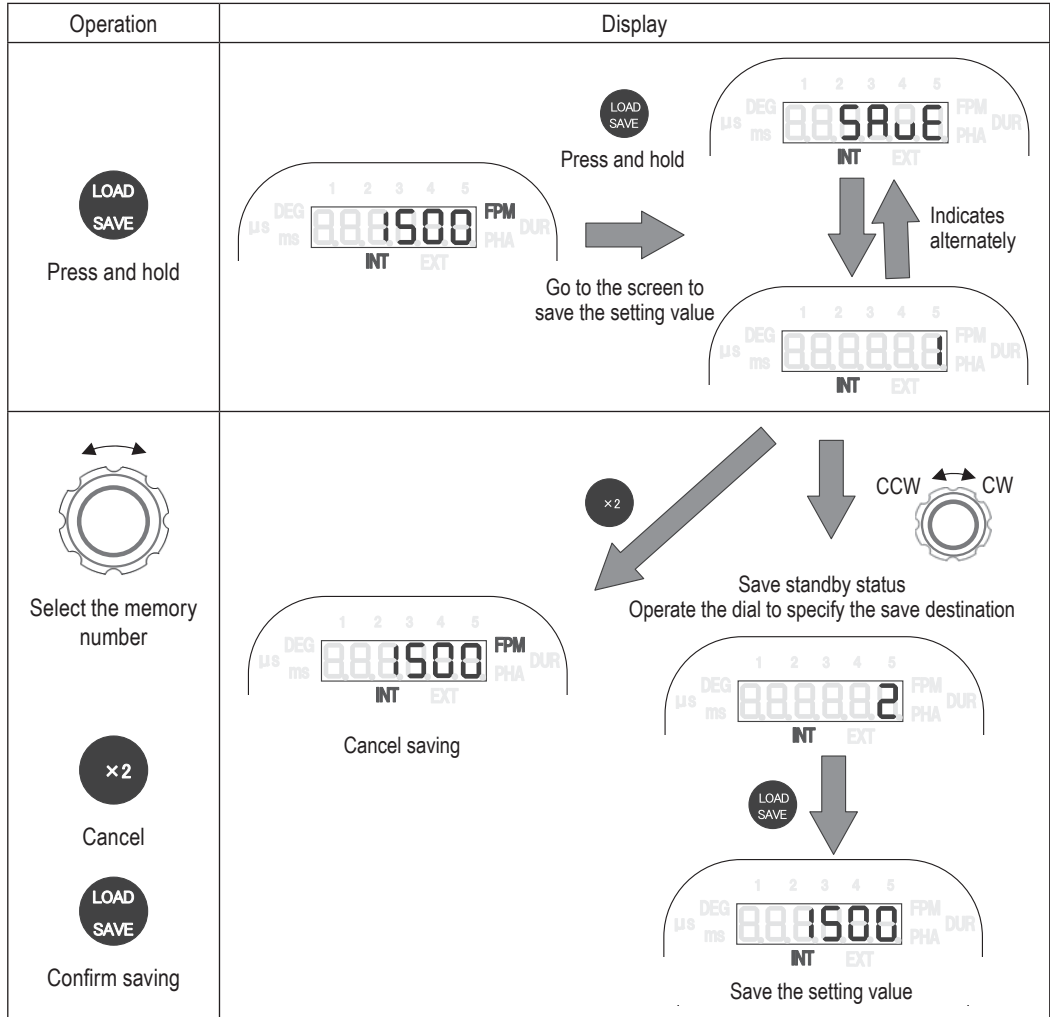

4.5.1.2 Saving on external synchronous emission

Press and hold the “LOAD(SAVE)” key in the external synchronous emission mode to save the setting value.

Press and hold the LOAD(SAVE) key to enter the save standby status. SAVE and the memory number in which the setting value is saved are indicated alternately. In this status, a memory number in which the setting value is saved can be changed using the dial operation.

Operate the dial to end alternate lighting and only a memory number in which the setting value is saved is indicated.

To save, press the “LOAD(SAVE)” key. The setting value is saved in the specified memory number and the display returns to the previous setting screen.

To cancel saving, press the x2 key. The save standby status ends and the display returns to the previous setting screen.

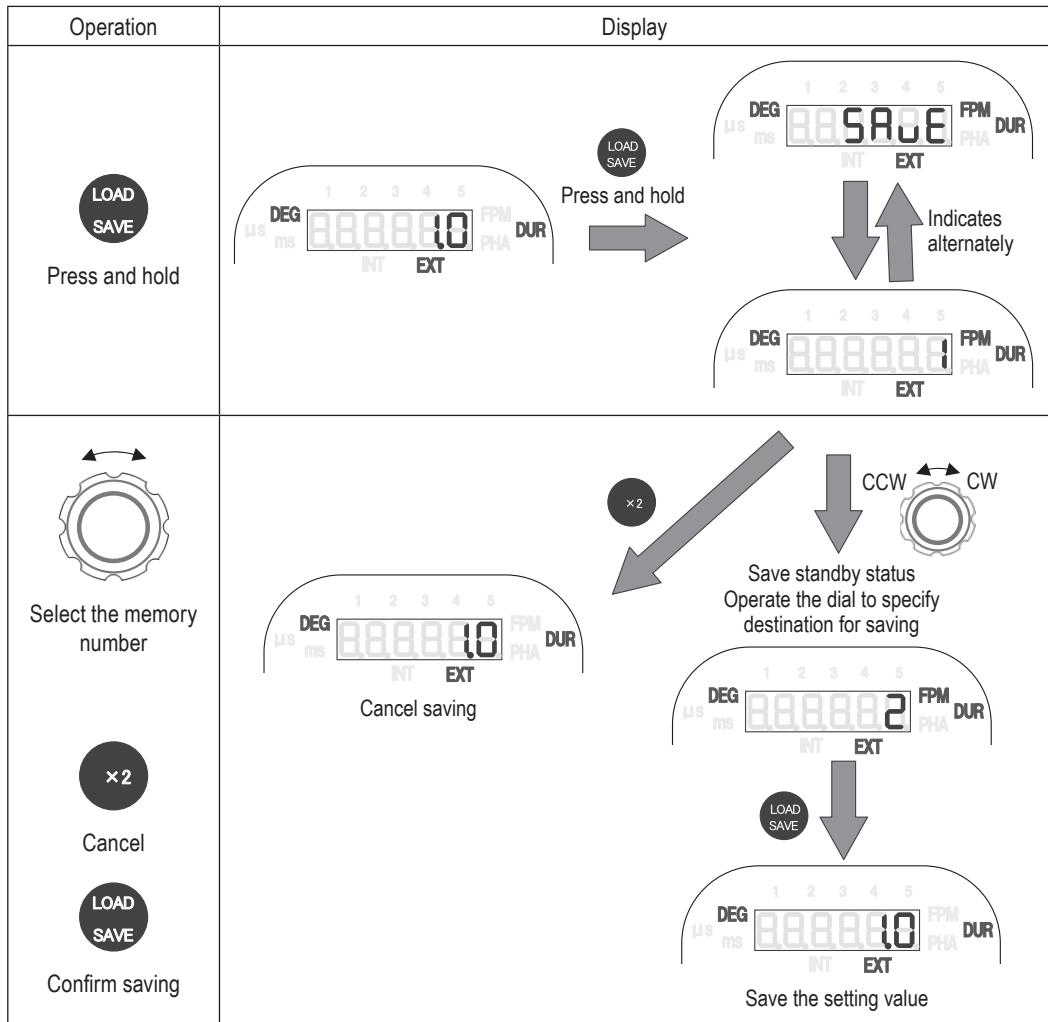

4.5.1.3 Saving the setting value when the power is OFF

While using the unit on internal oscillation emission and external synchronous emission, press the power switch and turn the power OFF to save the setting value to that which it was before turning the power OFF.

When the power is turned ON again, operation starts from the previous setting value.

4.5.2 Reading out each setting value

This function is used to read out each setting value.

4.5.2.1 Reading out on internal oscillation emission

Press the "LOAD(SAVE)" key in the internal oscillation emission mode to read out the setting value. Each press of the "LOAD(SAVE)" key changes the memory number to call.

Each press of the LOAD(SAVE) key changes the memory number in the order of 1->2->3->4->5->0 (free mode)->1->....

The memory number being read is indicated on the memory number display.

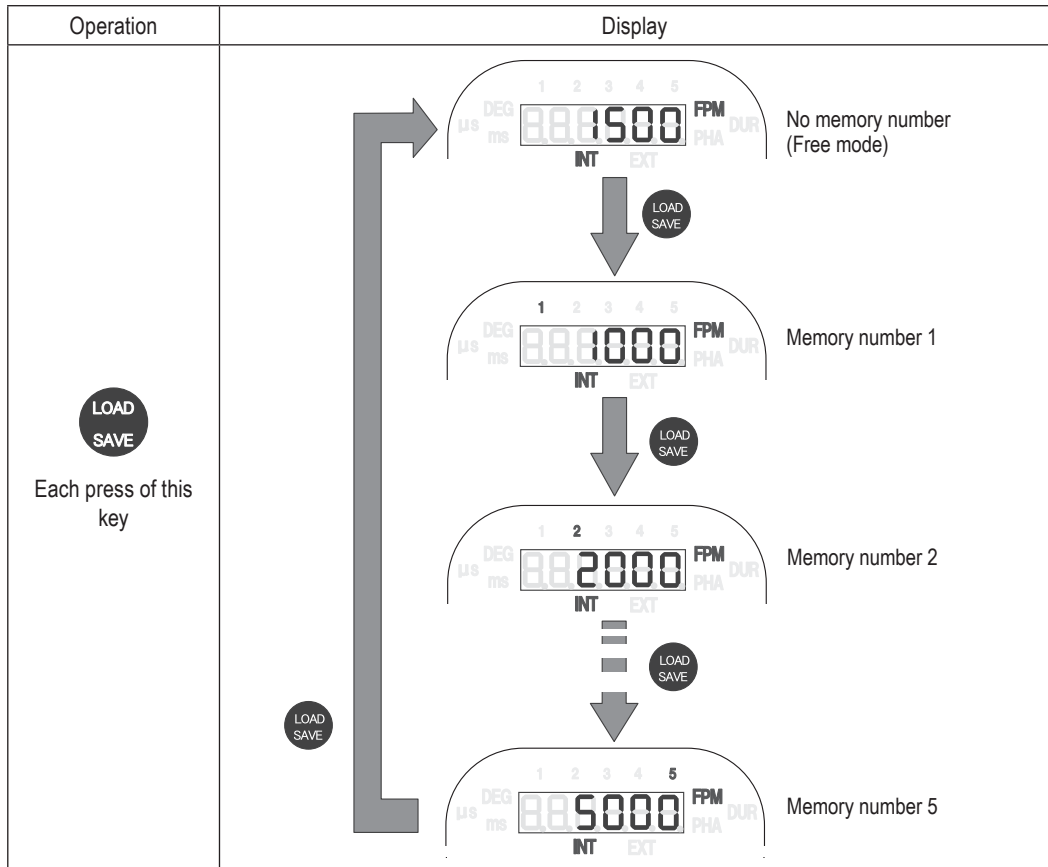

* After reading out the setting value, when any of the setting values for the emission count (FPM), emission angle (DUR) and/or delay time (PHA) are changed, the called memory number display goes off, and it goes to free mode.

4.5.2.2 Reading out on external synchronous emission

Press the "LOAD(SAVE)" key in the external synchronous emission mode to read out the setting value.

Each press of the "LOAD(SAVE)" key changes the memory number to call.

The memory number being read is indicated on the memory number display.

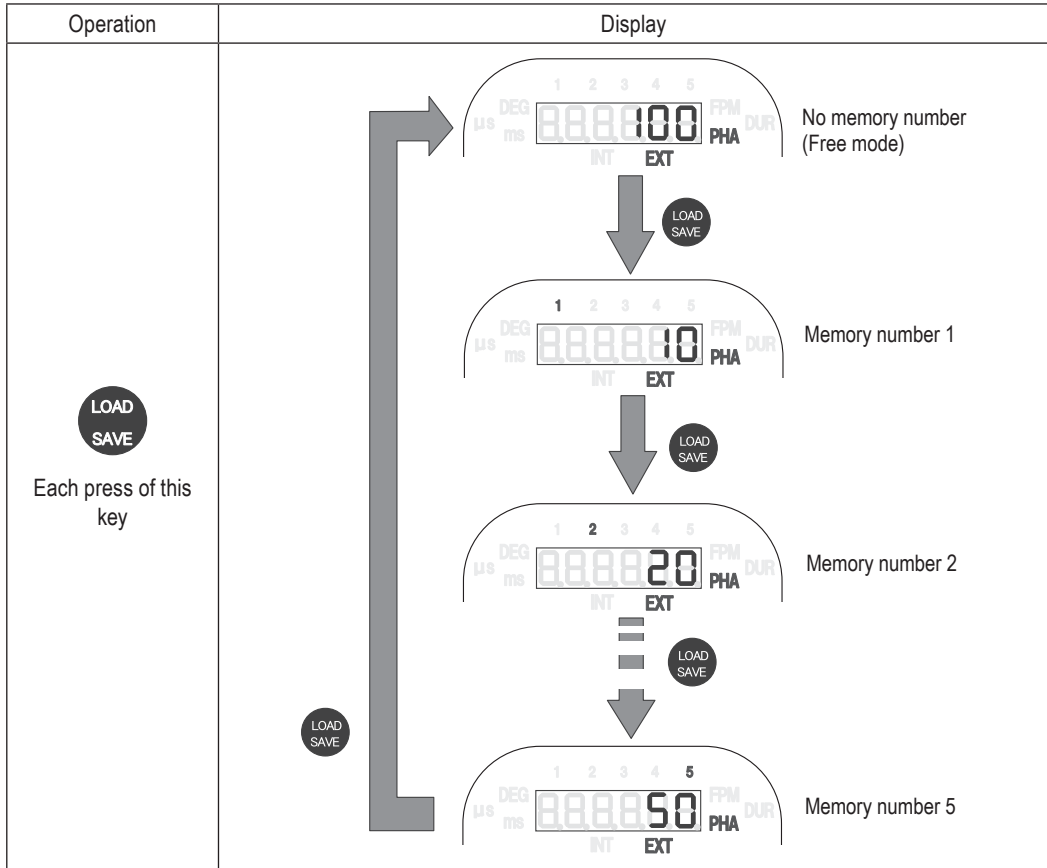

* After reading out the setting value, when any of the setting values for the emission count (FPM), emission angle (DUR), and/or delay time (PHA) are changed, the called memory number display goes off, then it goes to free mode.

4.6 Function mode

The following settings in the table can be configured in the function mode.

| | Setting item | Default setting value |
|-----------------|---------------------------------|-----------------------|
| Function mode 1 | Measurement range setting | 120,000 |
| Function mode 2 | Trigger edge setting | L-H |
| Function mode 3 | Auto emission stop time setting | 0 |
| Function mode 4 | External input signal setting | OFF |

4.6.1 Moving to the function mode

Turn the power ON while pressing the MODE key to enter the function mode.

During the function mode, press the MODE key to indicate the next setting item.

The items that have been set are collectively saved when function mode 4 is moved to the emission screen.

If the power is turned OFF in the middle of the function mode, the setting value will not be saved in the memory.

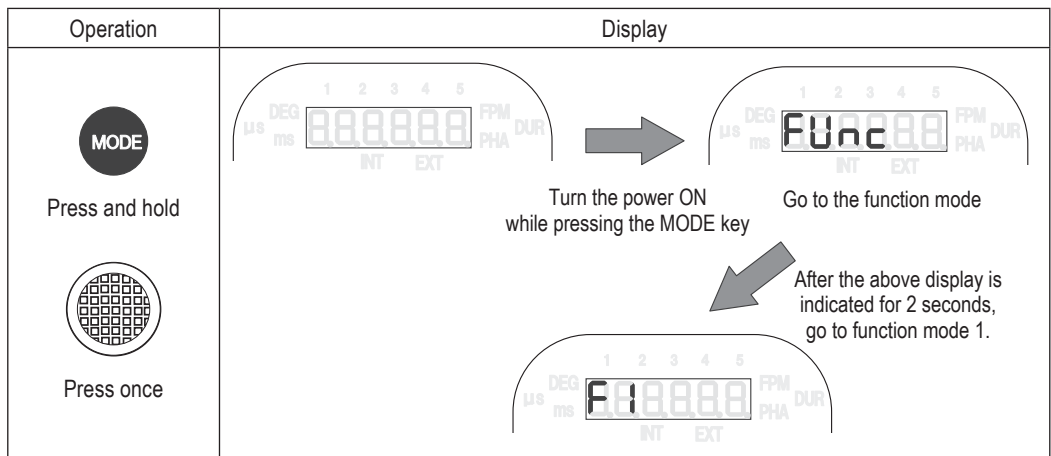

4.6.2 Measurement range setting (Function mode 1)

This function is used to set the measurement range on internal oscillation emission. The measurement range has two levels. The indicated contents depend on the measurement unit setting.

| Measurement unit | *Measurement range | |
|------------------|---|--|
| fpm | 60 to 12,000 (Available setting range: 60.0 to 12,000.0) | 60 to 120,000 (Available setting range: 60.0 to 12,000.0) |

* The emission count saved in the memory will be x10 or 1/10 by changing the measurement range.

Example: Save the emission count (frequency) of 6000 fpm in the range between 60 fpm and 120,000 fpm. After that, the saved value of the emission count (frequency) will be 600.0 fpm by changing the measurement range to between 60 fpm and 12,000 fpm.

* If the emission count (frequency) setting value is set to the one beyond (or below) the range when changing the measurement range, the value will be limited to the maximum (or minimum) value within the range.

Example 1: Save the emission count (frequency) of 60,000 fpm in the range between 60 fpm and 120,000 fpm. After that, the saved value of the emission count (frequency) will be 12,000.0 fpm by changing the measurement range to between 60 fpm and 12,000 fpm.

Example 2: Save the emission count (frequency) of 100 fpm in the range between 60 fpm and 120,000 fpm. After that, the saved value of the emission count (frequency) will be 60.0 fpm by changing the measurement range to between 60 fpm and 12,000 fpm.

Turn the dial to the CW direction to set the range to between 60 fpm and 120,000 fpm, and to the CCW direction to set the range to between 60 and 12,000.

Operate the dial to stop the alternate display, then only the measurement range setting value is indicated.

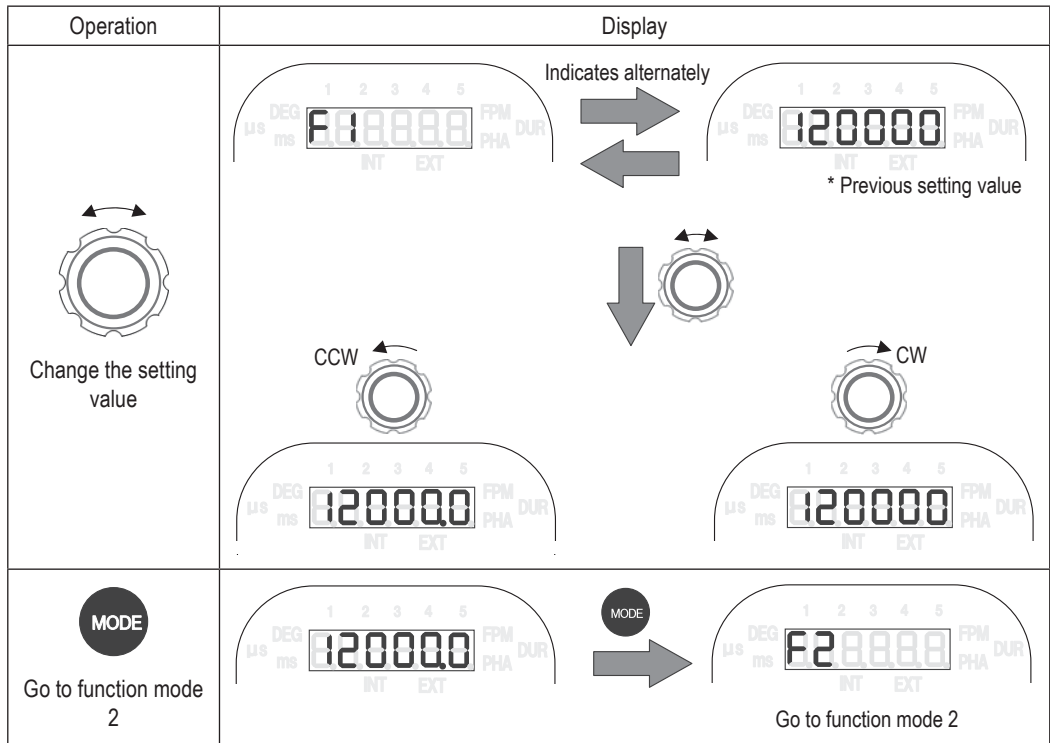

4.6.3 Trigger edge setting (Function mode 2)

In the external trigger mode in which the edge of the external pulse triggers emission, the rising edge or falling edge can be set.

●When the trigger edge is set to L-H

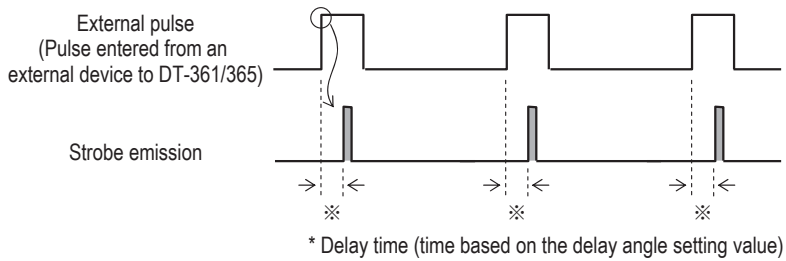

●When the trigger edge is set to H-L

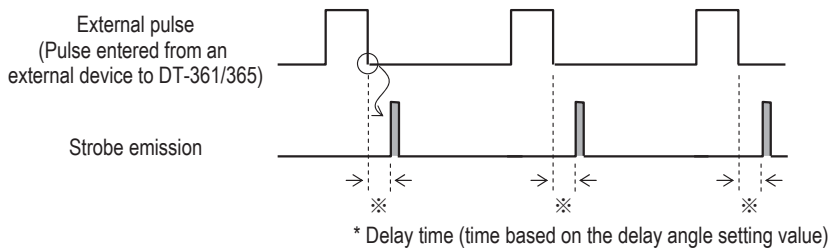

* With a NPN open collector connected, emission is performed at the rising edge when the trigger edge setting is L-H and at the falling edge when H-L.

Turn the dial to the CW direction to set the trigger edge to H-L (falling).
 Turn the dial to the CCW direction to set the trigger edge to H-L (rising).
 Operate the dial to stop the alternate display and only the trigger edge setting value is indicated.

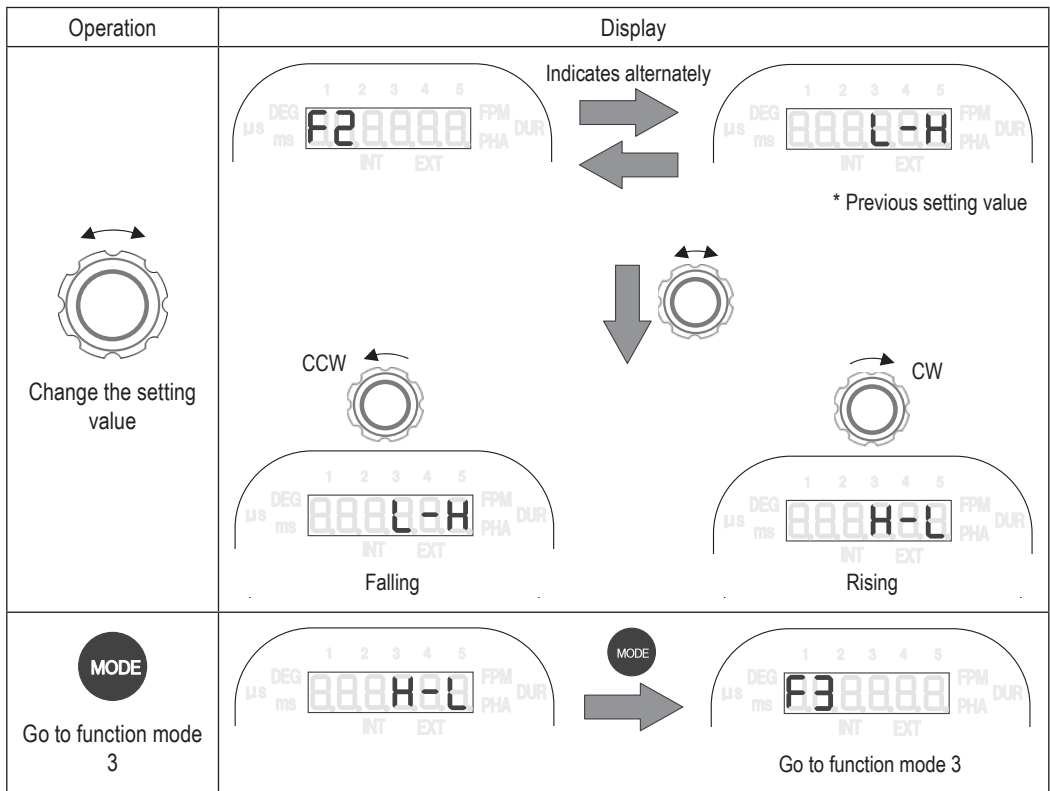

4.6.4 Auto emission stop time setting (Function mode 3)

This setting is used to stop the emission automatically when no operation is performed for a certain period of time.

The available setting time is within the range between 0 min and 120 min, which can be changed by 1 minute.

When it is set to 0, the auto emission stop function is turned OFF and emission is performed continuously.

When emission is stopped by the auto emission stop function, use the key or dial operations to restart emission.

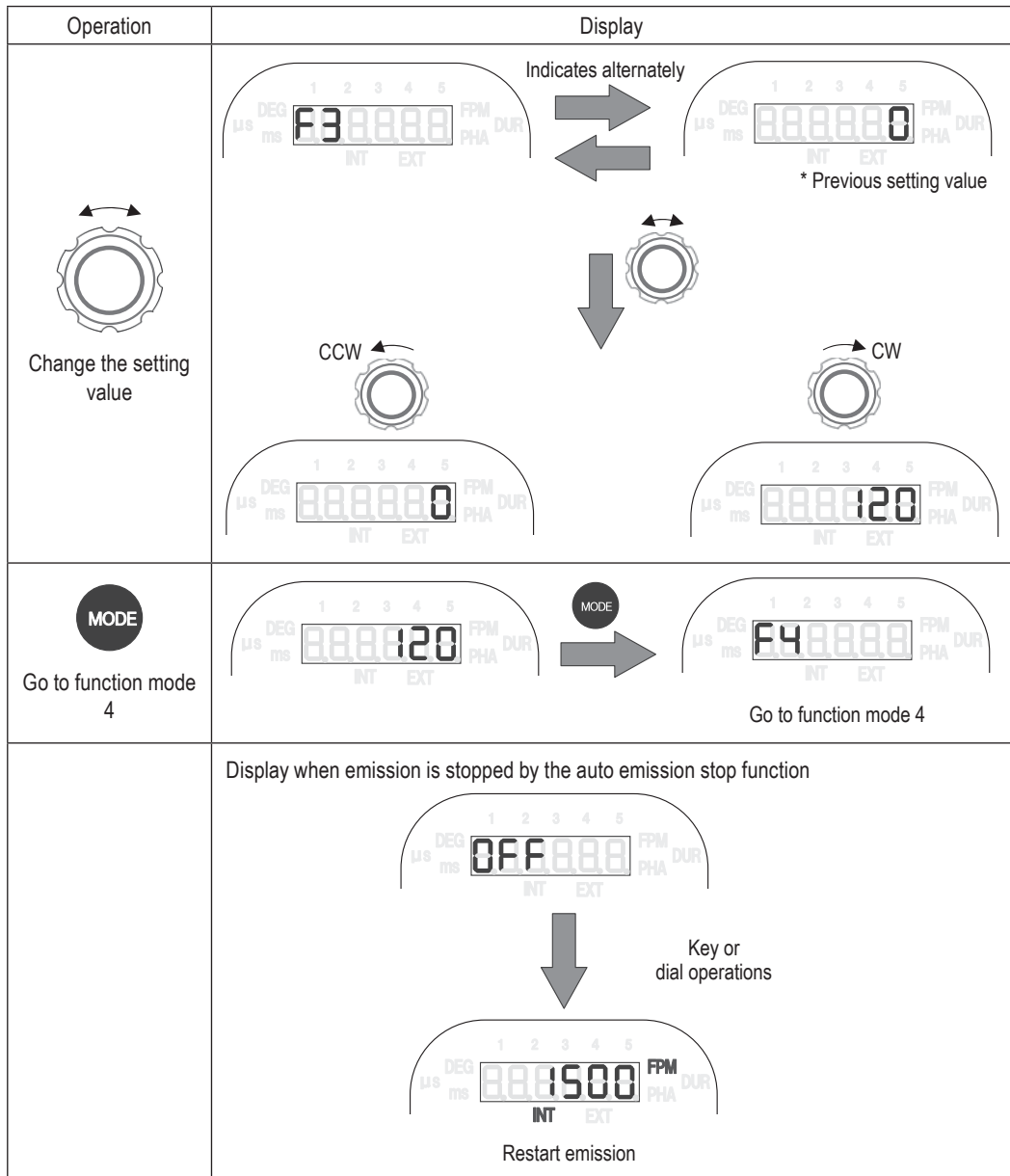

4.6.5 Input signal setting (Function mode 4)

Signals to be entered for external synchronous emission can be selected either from open collector input or voltage pulse input.

Set it to ON to select open collector input, and OFF to select voltage pulse input.

For details about the circuit, refer to **4.7.2 External pulse input**.

Press the MODE key to save the settings in the function mode and move to the emission screen.

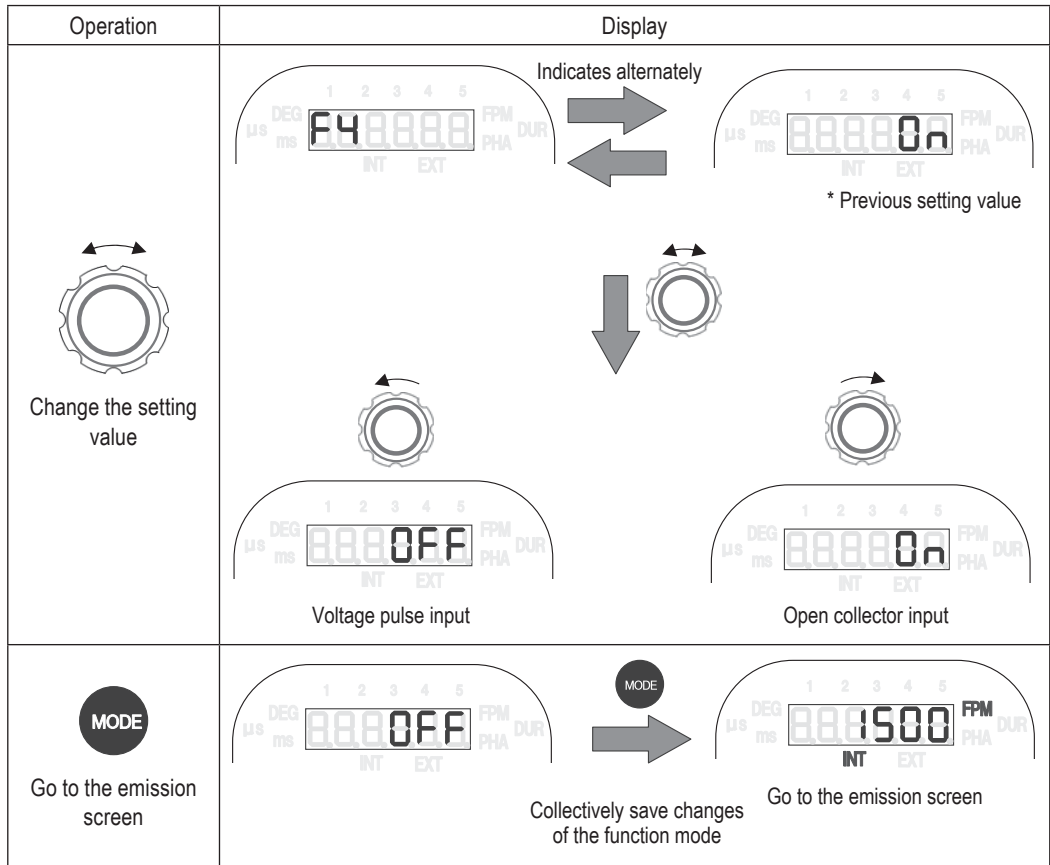

4.7 External I/O connector

4.7.1 Specifications for external I/O connector and pin assignment

•DT-361

| Pin number | Signal name | Remark |
|------------|-------------|------------------------------------|
| 1 | NC | — |
| 2 | NC | — |
| 3 | 12V | DC 12 V power output |
| 4 | OUT | External pulse output |
| 5 | IN | External pulse input |
| 6 | COM | External pulse input/output common |
| 7 | NC | — |
| 8 | NC | — |

Connector (on the side of DT-361): Hirose (RM15WTP-8S(7))

•DT-365

| Pin number | Signal name | Remark |
|------------|-------------|------------------------------------|
| 1 | +24V | DC 24 V power output + |
| 2 | G24 | DC 24 V power output - |
| 3 | 12V | DC 12 V power output |
| 4 | OUT | External pulse output |
| 5 | IN | External pulse input |
| 6 | COM | External pulse input/output common |
| 7 | NC | — |
| 8 | NC | — |

Connector (on the side of DT-361): Hirose (RM15WTP-8S(7))

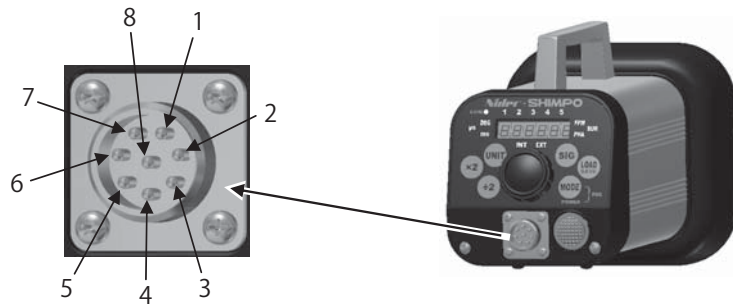

Connector pin number

4.7.2 External pulse input

Connect the unit to external devices (sensors, etc.) to allow the strobe to emit light using the pulse signal from those devices in the external trigger mode.

(For details, refer to **4.4 External synchronous emission**)

- Available input frequency : Available measurement range 40 to 35,000fpm
Available delay emission range 60 to 10,000fpm
- Available input pulse : Hi 2.5 to 12V
: Lo 0 to 0.5V
- Available input pulse width : 50 μ s or more
- Available delay setting angle: 0° to 359°, available to set by 1°
- Available delay setting time : 0 to 999 (max.) ms, available to set by 1 ms

[Input circuit]

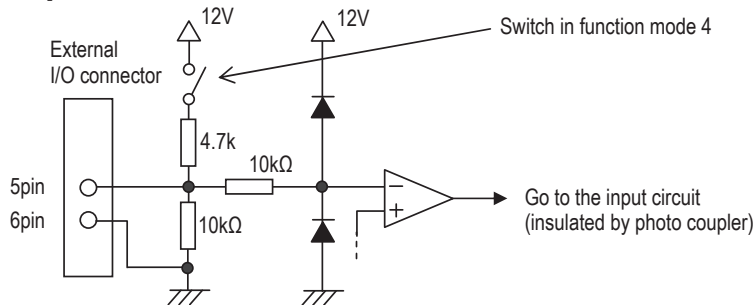

4.7.3 External trigger pulse output

Output the pulse to external devices simultaneously with emission while emission is performed in the internal oscillation mode or external trigger mode.

A delay of approximately 30 μ s caused by the internal circuit exists.

- Output circuit specification : 12 V voltage output
- Output pulse width : Approx. 200 μ s

[Output circuit]

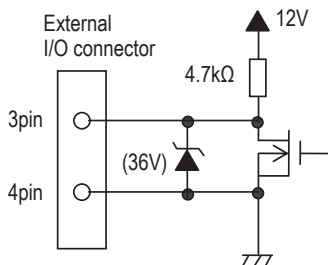

[Output timing]

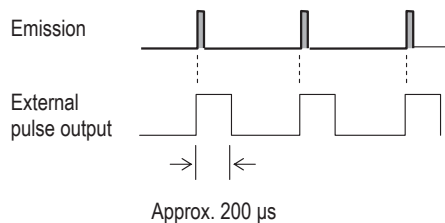

Inside DT-361/365

5 Specifications

| Model | | DT-361 | DT-365 | |
|-------------------------------|---|--|--|--|
| Application | | AC power input model | Charging battery built-in model | |
| Internal oscillation emission | Emission count | 60 to 120,000fpm | | |
| | Setting accuracy | ±0.02% | | |
| | Measurement range setting | Available to set to the range between 60 fpm and 120,000 fpm, or 60 fpm and 12,000 fpm (Set in function mode 1) | | |
| | Setting display resolution (internal oscillation) | Measurement range: 60 to 12,000fpm | 60.0 to 3,000.0 : 0.1fpm 3,000.2 to 6,000.0 : 0.2fpm 6,000.5 to 12,000.0 : 0.5fpm | |
| | | Measurement range: 60 to 120,000fpm | 60.0 to 30,000 : 1fpm 30,00.2 to 60,000 : 2fpm 60,00.5 to 100,000 : 5fpm 100,010 to 120,000 : 10fpm | |
| | Function to change the emission frequency setting | Available to change the emission frequency to an optional value Available to change the emission frequency to double or half of the current value (Each press of the key changes the value to double, quadruple..., or half, one-quarter, ...) | | |
| | Phase change function | Based on the current emission phase, For angle setting: by 1° within the range between 0° and 359° For time setting: by 1 ms within the range between 0 and 999 ms (max.) | | |
| External synchronous emission | Input interface | Voltage pulse input or open collector input of Hi: 2.5 V to 12 V and Lo: 0 V to 0.5 V (Set in function mode 4) | | |
| | Pulse output interface | 12 V voltage pulse output Pulse width: Approx. 200 μs | | |
| | Synchronous edge switch | Available to select either the rising edge or falling edge (Set in function mode 2) | | |
| | Frequency measurement range | 40 to 35,000fpm | | |
| | Available delay emission range | 60 to 10,000fpm | | |
| | Available phase setting range | Delay angle: by 1° within the range between 0° and 359° Delay time: by 1 ms within the range between 0 and 999 ms (max.) | | |
| | Sensor power | DC12V/max50mA | | |
| Emission duration | Angle | Available to set by 0.1° within the range between 0.1° and 3.6° (/360°) | | |
| | Time | Max. 400 μsec | | |
| Display | | 6-digit red LED | | |
| Setting devices | | Multi-turn encoder, tact switch | | |
| Emission source | | Ultra luminosity LED 18 lights | | |
| Connector | | I/O signal connector | Power supply and I/O signal integrated connector | |

* 1 A delay of approximately 30 μs caused by the internal calculation process will be added.

| | | |
|-----------------------|---|--|
| Memory function | <ul style="list-style-type: none"> •Saving the setting value when the power is OFF •Saving 5 setting values each on internal oscillation and external synchronous emission respectively | |
| Auto emission stop | Available to set continuous emission, or set the time to stop emission by 1 minute within the range between 1 min and 120 min. (Set in function mode 3) | |
| Power | AC100 to 230V(50Hz/60Hz) | Built-in NiMH battery <ul style="list-style-type: none"> •Continuous emission time Approx. 2 hours (when the emission duration is set to 3.6°) Approx. 5 hours (when the emission duration is set to 1.0°) •Charging time: Approx. 2.5 hours Supplied AC adapter <ul style="list-style-type: none"> •Input : AC100 to 230V •Output : DC24V |
| Operating temperature | 32 to 95 F (0 to 35 °C) | |
| Operating humidity | 35 to 85%RH | |
| Operating environment | No dust and/or corrosive gases | |
| Compliance standard | RoHS | |
| Protection structure | Equivalent to IP65 NEMA 4X | |
| Weight | Approx. 4 lb (1.8 kg) | Approx. 4.6 lb (2.1 kg) |
| Standard accessories | External I/O connector (8 pin) x 1 | Dedicated AC adapter x 1 |

6 External dimensions

[DT-361]

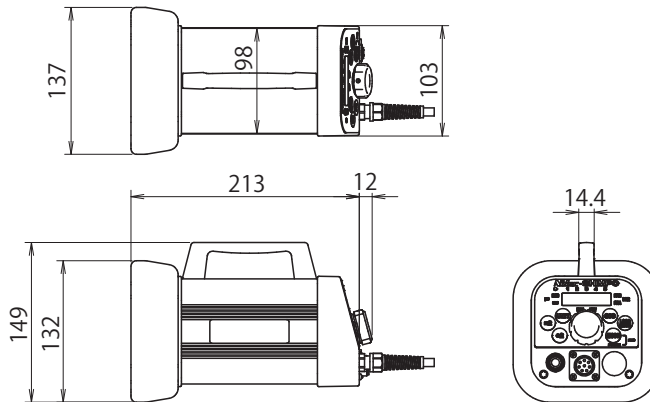

[DT-365]

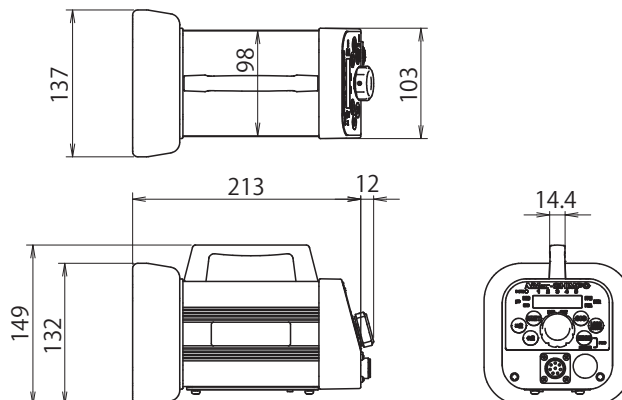

7 Trouble shooting

| Symptoms | Factors | Causes | Treatment |
|--|------------------------------|--|--|
| DT-365 does not flash and the display shows LLLLLLL. | Battery voltage is low | Battery is not charged | Please charge the battery |
| The display of DT-365 shows LLLLLLL even though the battery is fully charged | Less capacity in the battery | Battery lifetime Something wrong with the battery Something wrong with the circuit | Replace the battery Please send it for repair if the problem is not fixed after replacing the battery |
| DT-365 does not flash even though the power plug is connected. | No power at the LED strobe | AC power plug is not connected | Check the connection |
| | | AC power plug is broken. | Send for repair |
| The battery charging lamp for DT-365 does not go off even after charging is finished | Charging not done. | Battery lifetime Something wrong with the battery Something wrong with the circuit | Replace the battery Please send it for repair if the problem is not fixed after replacing the battery |
| Flashing is not stable or stop | Breakage in internal circuit | Breakage in internal circuit | Send for repair |
| The display or FPM does not change even though the operation dial is rotated. | Breakage in internal circuit | Breakage in internal circuit | Send for repair |
| The display show the proper FPM but the actual flash rating does not change. | Breakage in internal circuit | Breakage in internal circuit | Send for repair |
| The display does not show anything,. The strobe also does not flash at all. | Breakage in internal circuit | Breakage in internal circuit | Send for repair |