

HORIBACODE:GZ0000438938
February, 2016 © 2016 HORIBA, Ltd.

pH/Water Quality Meter F-7X BW

Low-spec Command Reference

■ Preface

This manual describes the communication command list of the pH/Water Quality Meters with serial communication function, LAQUA-PH1100/PH1200/PH1300/PC1100/EC1100.

The contents of this manual are subject to change without notice.

■ Caution

- Use the optional USB cable (part number: 3200373941) or serial cable (part number: 3014030151) to connect the instrument to a personal computer (referred to as PC in the rest of this document).
- Make sure that the transfer format used in the instrument and a PC are the same. When different transfer format is used, a communication error occurs and the online mode does not start up, and as a result RS-232C communication cannot be performed. Also, when the transfer format is changed, turn OFF the power of the instrument and PC and then reboot them.

The transfer format of the instrument is as follows.

- Baud rate: 2400 bps
 - Character length: 8 bits
 - Parity: None
 - Stop bit: 1 bit
- If you write the program for serial communication, at first, write the command to change the instrument to the online mode. By changing the instrument to the online mode, its operation keys except for  key are locked and it changes to serial communication mode. If the instrument's power is turned OFF, reset the online mode.
 - If the instrument does not receive the command or occurs any errors after it requested the data, add the waiting time of a few seconds before request the data again. If the instrument received the data continuously, the instrument does not response.
 - The instrument cannot be controlled by using the DCD, CTS, and DSR.
 - It is necessary to switch RTS to ON to perform communication. Set it 2.4 V above.
 - Pin assignment of the instrument and the external instrument are follows.

Instrument side (A connector MINI DIN 8 PIN)

- 2 TX
- 3 RX
- 4 CTS
- 5 COM

External instrument side (B connector DSUB 9 PIN)

- 2 TX (RX at an external instrument side)
- 3 RX (TX at an external instrument side)
- 5 COM
- 7 CTS (RTS at an external instrument side)

• Command function list (control)

Item	Command		Function
	Header	Name	
Online/Offline	C (Control)	OL	Changes between the online mode and the offline mode.
Potential follow-up stop		BR	Releases the hold state and returns to instantaneous value display state.
pH measurement mode		PH	Waits for the pH measurement.
mV measurement mode		MV	Waits for the ORP measurement mode result.
Ion measurement mode		IO	Waits for the ion measurement.
Conductivity measurement mode		CO	Waits for the conductivity measurement.
Salinity measurement mode		SA	Waits for the salinity measurement.
Resistivity measurement mode		OH	Waits for the resistivity measurement.
TDS measurement mode		TD	Waits for the TDS measurement.
Calibration mode		CM	Waits for the calibration.
pH calibration start		CP	Starts the calibration and inspection before use in the pH measurement mode or hold state.
Ion calibration start		CI	Starts the ion calibration in the ion measurement mode or hold state.
Conductivity calibration start		CD	Starts the conductivity calibration in the conductivity measurement or hold state.
Salinity calibration start		CS	Starts the salinity calibration in the salinity measurement or hold state.
Calibration clear		CC	Clears the calibration data in the measurement mode.
Data IN		IN	Stores the measurement data.

Response from pH meter

OK [CR][LF]

or

ER, n [CR][LF]

- n = 1: A non-existent command was entered.
- n = 2: The command was entered when the pH meter cannot accept it.
- n = 3: An unacceptable number was entered in the command.

● **Online/Offline command**

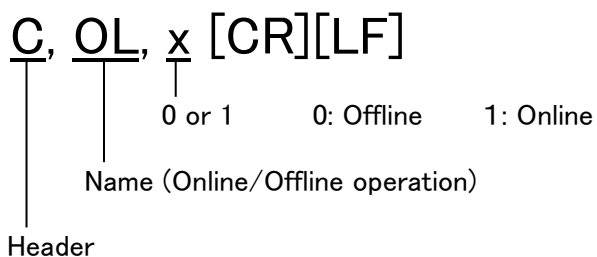

When the instrument accepts the online command, it enters the online mode and the keys cannot be operated.

● **Potential follow-up stop command**

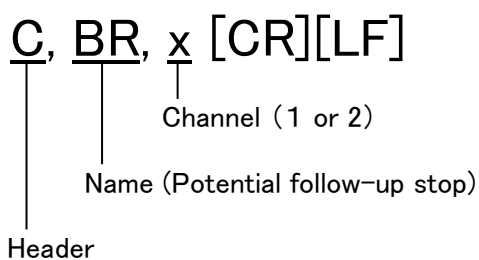

Releases the hold state and returns to instantaneous value display state.
This is invalid for auto stability mode.

● **pH measurement mode command**

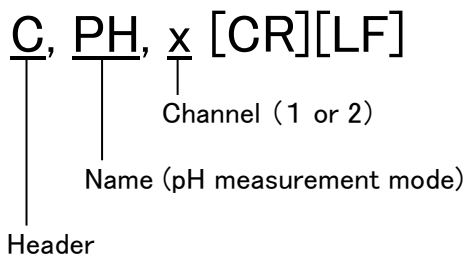

When the instrument is in the online mode, this is valid for modes other than the calibration mode.
Waits for the pH measurement.

● **mV measurement mode command**

C, MV, x [CR][LF]

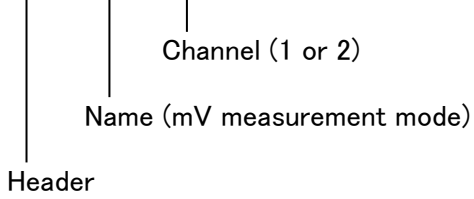

When the instrument is in the online mode, this is valid for modes other than the calibration mode. Waits for the ORP measurement mode result.

● **Ion measurement mode command**

C, IO, x [CR][LF]

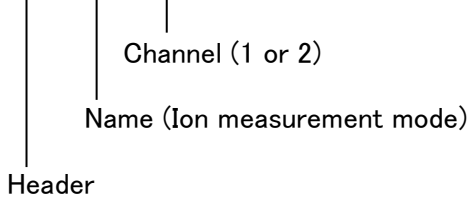

When the instrument is in the online mode, this is valid for modes other than the calibration mode. Waits for the ion measurement.

● **Conductivity measurement mode command**

C, CO [CR][LF]

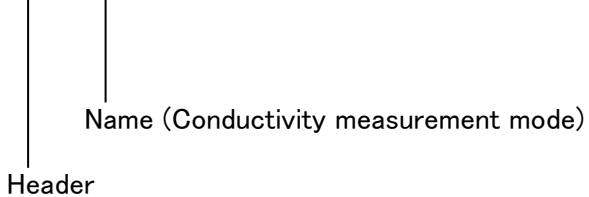

When the instrument is in the online mode, this is valid for modes other than Calibration mode. Waits for the conductivity measurement.

● **Salinity measurement mode command**

C, SA [CR][LF]

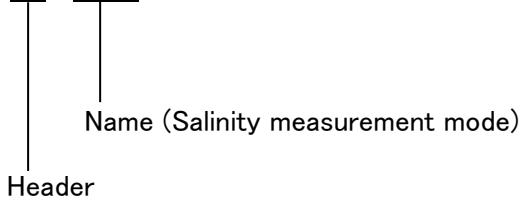

When the instrument is in the online mode, this is valid for modes other than the calibration mode. Waits for the salinity measurement.

● **Resistivity measurement mode command**

C, OH [CR][LF]

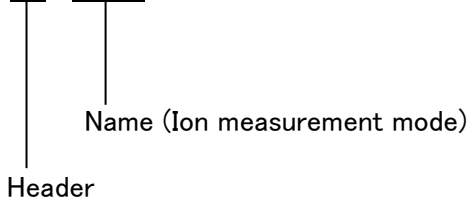

When the instrument is in the online mode, this is valid for modes other than the calibration mode. Waits for the resistivity measurement.

● **TDS measurement mode command**

C, TD [CR][LF]

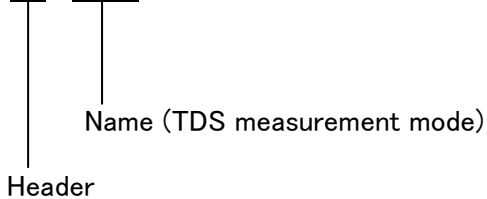

When the instrument is in the online mode, this is valid for modes other than the calibration mode. Waits for the TDS measurement.

● Calibration mode command

C, CM, x, y [CR][LF]

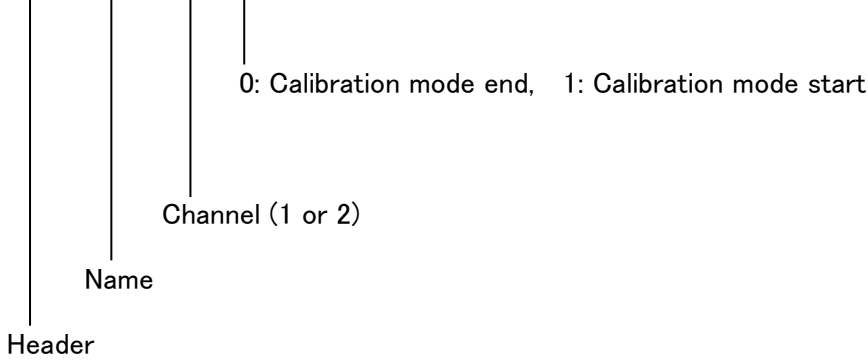

Waits for the calibration at specified mode.

※ To return to the measurement mode without calibrating after entering the calibration mode, enter "0: Calibration mode end".

● pH calibration start command

C, CP, x, xxxxxx [CR][LF]

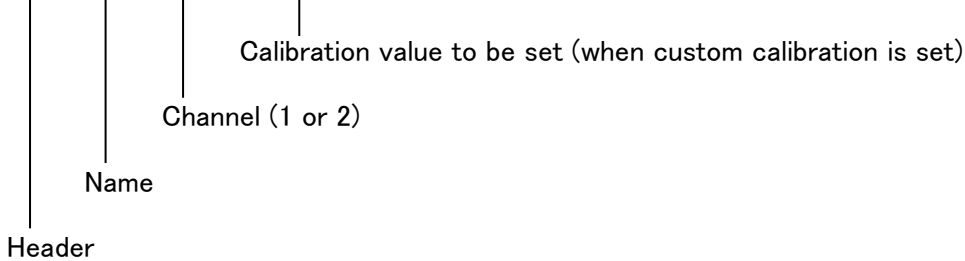

Starts the calibration when waiting for pH calibration.

Even when the setting is other than the custom calibration, it is necessary to enter the calibration value (It will not be used.).

ER, 2 is returned when the measurement value or temperature value is Or (Ur).

Setting range of calibration value

Specified by three decimal places.

0.000 to 14.000

- ※ Automatically returns to the measurement mode after the calibration is finished.
- ※ Automatically returns to the measurement mode even if a calibration error is generated.
- ※ A calibration error can be checked by the alarm inquiry (R, AL).
- ※ Calibration errors are released by the alarm clear (R, AR).

● Ion calibration start command

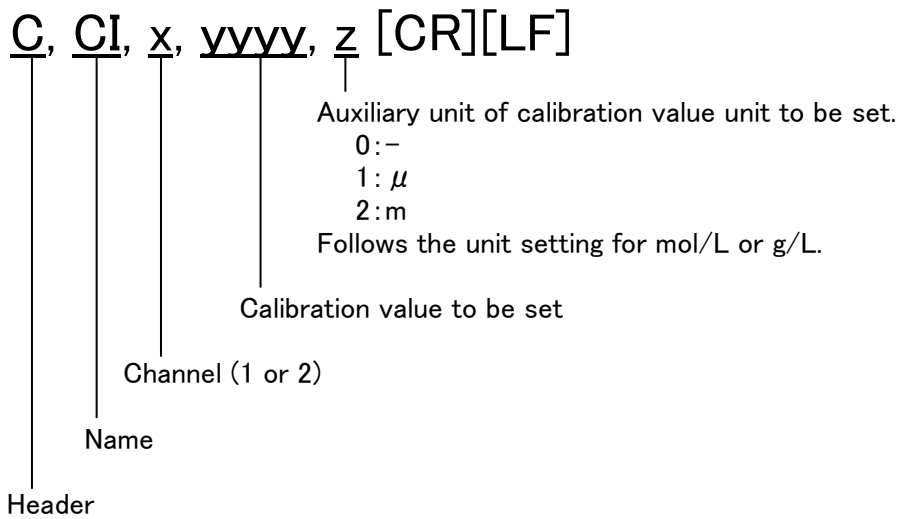

Starts the ion calibration when waiting for ion calibration.
 ER, 2 is returned when the temperature value is Or (Ur).
 Calibration is possible when the measurement value is Or (Ur).

Setting range of calibration value

Unit: mg/L, μ g/L, mmol/L, μ mol/L

0.00 to 9.99

(Possible at [SP][SP]X or [SP]X.X.)

10.0 to 99.9

(Possible even at [SP]XX.)

[SP]100 to [SP]999

- ※ Automatically returns to the measurement mode after the calibration is finished.
- ※ Automatically returns to the measurement mode even if a calibration error is generated.
- ※ A calibration error can be checked by the alarm inquiry (R, AL).
- ※ Calibration errors are released by the alarm clear (R, AR).

● Conductivity cell constant calibration start command

C, CD, yyyyy, z [CR][LF]

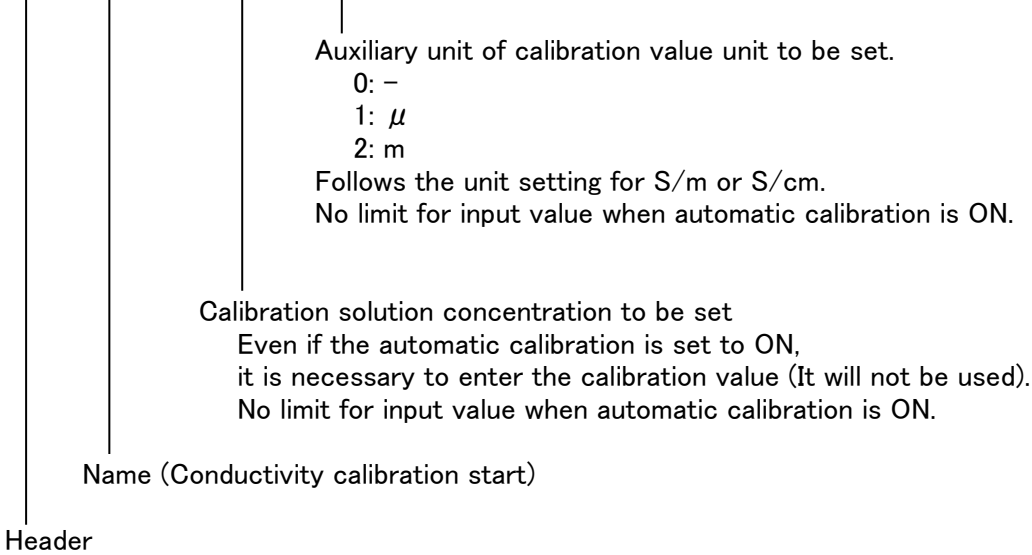

Starts the conductivity calibration when waiting for conductivity calibration.
 ER, 2 is returned when the measurement value or temperature value is Or (Ur).

Setting range of calibration value

When the unit is μ S/m: 0.001 to 2000.0
 When the unit is mS/m or S/m: 0.001 to 200.0

- ※ Automatically returns to the measurement mode after the calibration is finished.
- ※ Automatically returns to the measurement mode even if a calibration error is generated.
- ※ A calibration error can be checked by the alarm inquiry (R, AL).
- ※ Calibration errors are released by the alarm clear (R, AR).

● Calibration clear command

C, CC, x [CR][LF]
Header Name (Calibration clear)
 Channel (1 or 2)

Clears the calibration data in the measurement mode.

● Data IN command

C, IN [CR][LF]
Header Name (Data IN)

Stores the measurement data.

• Command function list (Request data)

Item	Command		Function
	Header	Name	
Request of the calibration history of pH	R (Request Data)	PC	Gets the latest calibration history of pH.
Request of the calibration history of ion		IC	Gets the latest calibration history of ion.
Request of the calibration history of conductivity		CC	Gets the latest calibration history of conductivity.
Request of the measurement value		MD	Gets the measurement value of specified channel.
Request of the clock data		OT	Gets the clock data.
Request of the number of stored memories		MC	Gets the number of data stored in the memory.
Request of memory data		MS	Gets the memory data to be specified.
Alarm inquiry		AL	Gets the alarm code in the instrument.
Clear alarm		AR	Clears the alarm code in the instrument.

Response from pH meter

When it is OK:

Describes in each command.

or

ER, n [CR][LF]

n = 1: A non-existent command was entered.

n = 2: The command was entered when the pH meter cannot accept it.

n = 3: An unacceptable number was entered in the command.

●Request command and response of the calibration history of pH

Request command

R, PC, x [CR][LF]

Channel

Name (Request of calibration history of pH)

Header

Response from pH meter

RPC, x, x, x, x, Xxxxx.x, x, (=>)

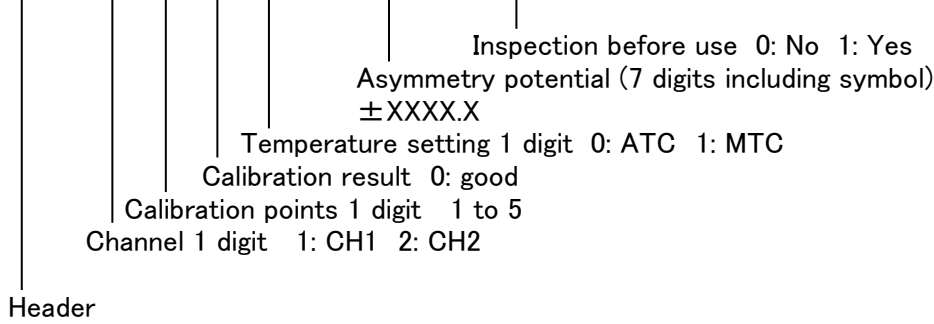

Slope (sensitivity) (5 digits including decimal point and symbol)

For one-point calibration=>First-point sensitivity: [SP]

For two-point calibration=>First-point sensitivity: Potential diff. between 1st and 2nd solutions, second-point sensitivity [SP]

For three-point calibration=>First-point sensitivity: Potential diff. between 1st and 2nd solutions, second-point sensitivity: Potential diff. between 2nd and 3rd solutions, third-point sensitivity [SP]

For four-point calibration=>First-point sensitivity: Potential diff. between 1st and 2nd solutions, second-point sensitivity: Potential diff. between 2nd and 3rd solutions, third-point sensitivity: Potential diff. between 3rd and 4th solutions, fourth-point sensitivity [SP]

For five-point calibration=>First-point sensitivity: Potential diff. between 1st and 2nd solutions, second-point sensitivity: Potential diff. between 2nd and 3rd solutions, third-point sensitivity: Potential diff. between 3rd and 4th sensitivity solutions, fourth-point sensitivity: Potential diff. between 4th and 5th solutions, fifth-point sensitivity [SP]

(=>)

xxxx,	xx,	xx,	xx,	xx,	xx,	xx.xxx,	Xxxx.x,	Xxxxx.x,	xxx.x
						xx.xxx,	Xxxx.x,	Xxxxx.x,	xxx.x
						xx.xxx,	Xxxx.x,	Xxxxx.x,	
						xx.xxx,	Xxxx.x,	Xxxxx.x,	x.xxx

First point calibration
Second point calibration
Third point calibration
[CR][LF] Inspection data before use

Repeatability (5 digits including decimal point and symbol) 0.000 to 9.999

Potential (7 digits including symbol) ±XXXX.X

Temperature (6 digits including decimal point and symbol) ±XXX.X
Calibration solution value (6 digits including decimal point and symbol) 0.000 to 14.000

Second 2 digits 00 to 59

Minute 2 digits 00 to 59

Hour 2 digits 00 to 23

Day 2 digits 01 to 31

Month 2 digits 01 to 12

Year 4 digits A.D.

Response from the instrument if it does not have the calibration data

RPC,***x,0,3**

Channel 1 digit 1:CH1 2:CH2

Display format is fixed. If no data exist, [SP] is displayed.
The number of transmitted calibration data is the number of calibration points.
Displayed calibration date and time is the latest calibration date and time.
When there are two or more calibration points,
slope data is displayed and the slope data of the third point is a space.
If an inspection is carried out before use, its data will be transmitted after the calibration data is forwarded.

Slope data

For the slope data, the calibration efficiency, A X 100, between each point is output.
When it exceeds 999.9 or is a negative value, [SP][SP][SP][SP][SP] is output.

● Request command and response of the calibration history of ion

Request command

R, IC, x [CR][LF]

Channel

Name (Request of the calibration history of ion)

Header

Collects the ion data under selection.

Response from pH meter

RIC, x, x, x, x, Xxxxx.x, X, X, (⇒)

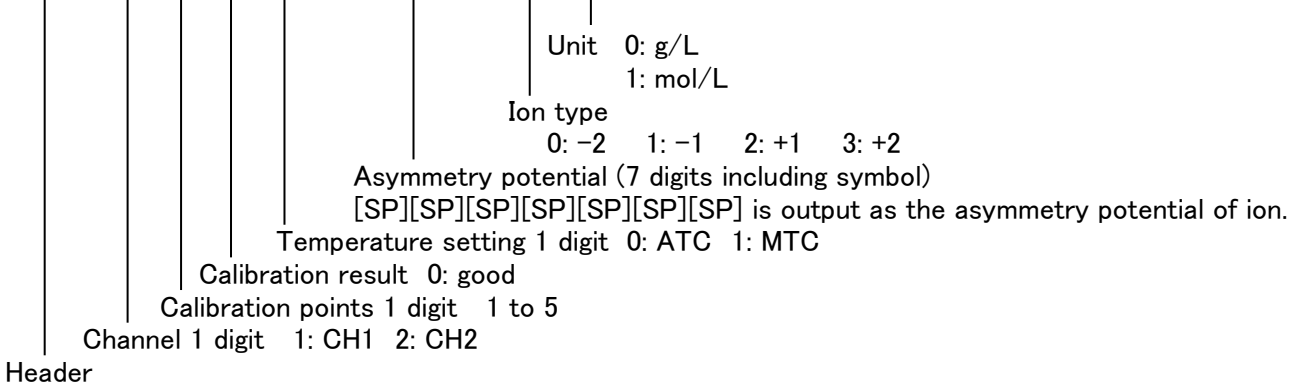

Slope (sensitivity) (5 digits including decimal point and symbol)

For one-point calibration ⇒ First-point sensitivity: [SP]

For two-point calibration ⇒ First-point sensitivity: Potential diff. between 1st and 2nd solutions, second-point sensitivity [SP]

For three-point calibration ⇒ First-point sensitivity: Potential diff. between 1st and 2nd solutions, second-point sensitivity: Potential diff. between 2nd and 3rd solutions, third-point sensitivity [SP]

For four-point calibration ⇒ First-point sensitivity: Potential diff. between 1st and 2nd solutions, second-point sensitivity: Potential diff. between 2nd and 3rd solutions, third-point sensitivity: Potential diff. between 3rd and 4th solutions, fourth-point sensitivity [SP]

For five-point calibration ⇒ First-point sensitivity: Potential diff. between 1st and 2nd solutions, second-point sensitivity: Potential diff. between 2nd and 3rd solutions, third-point sensitivity: Potential diff. between 3rd and 4th sensitivity solutions, fourth-point sensitivity: Potential diff. between 4th and 5th solutions, fifth-point sensitivity [SP]

(⇒)

xxxx,	xx,	xx,	xx,	xx,	xx,	xxxx	x,	Xxxx.x,	Xxxxx.x,	xxx.x
						xx.x	x,	Xxxx.x,	Xxxxx.x,	xxx.x
						x.xx	x,	Xxxx.x,	Xxxxx.x,	
						xxxx	x,	Xxxx.x,	Xxxxx.x,	x.xxx

First point calibration
Second point calibration
Third point calibration

[CR][LF]

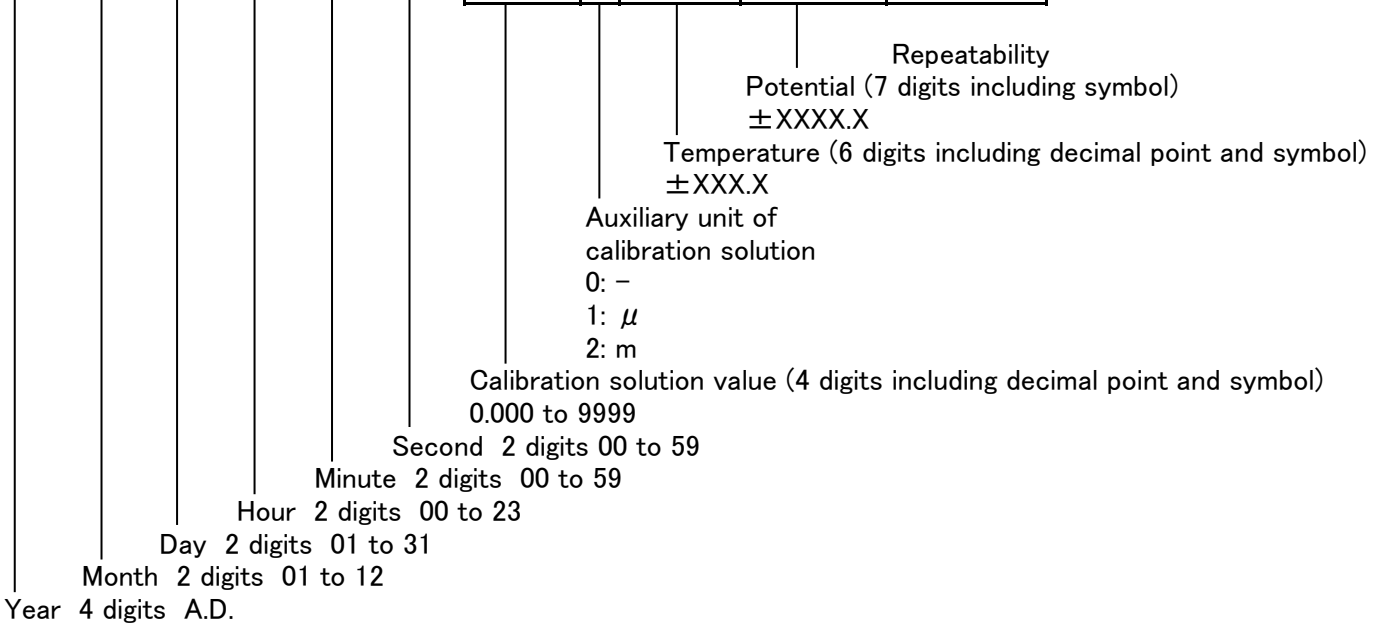

Response from the instrument if it does not have the calibration data

RIC,***x,0,3**

Channel 1 digit 1:CH1 2:CH2

● Request command and response of the calibration history of conductivity

Request command

R, CC [CR][LF]

Name (Request of the calibration history of conductivity)

Header

Response from pH meter

RCC, X, X, X, (=>)

Header
 Channel 1 digit 1: CH1 2: CH2
 Calibration result 0: good
 Temperature setting 1 digit 0: ATC 1: MTC

(=>)

xxxx,	xx,	xx,	xx,	xx,	xx,	xxx.x	xxx.x,	X,	X,	Xxxx.x,	Xxxxx.x,	X.XXX
							xxx.x,	X,	X,	Xxxx.x,	Xxxxx.x,	X.XXX
							xxx.x,	X,	X,	Xxxx.x,	Xxxxx.x,	X.XXX
							xxx.x,	X,	X,	Xxxx.x,	Xxxxx.x,	X.XXX
							xxx.x,	X,	X,	Xxxx.x,	Xxxxx.x,	X.XXX

Range 5 calibration data
 Range 4 calibration data
 Range 3 calibration data
 Range 2 calibration data
 Range 1 calibration data

[CR][LF]

Cell coefficient
 Potential (7 digits including symbol)
 ±XXXX.X
 Temperature (6 digits including decimal point and symbol)
 ±XXX.X
 Auxiliary unit
 0: -
 1: μ
 2: m
 Unit
 0: S/m
 1: S/cm
 Calibration solution value (5 digits including decimal point and symbol)
 0.000 to 199.9
 Cell constant
 Second 2 digits 00 to 59
 Minute 2 digits 00 to 59
 Hour 2 digits 00 to 23
 Day 2 digits 01 to 31
 Month 2 digits 01 to 12
 Year 4 digits A.D.

Display format is fixed. If no data exist, [SP] is displayed.
 Displayed calibration date and time is the latest calibration date and time.
 For the calibration solution concentration, unit, auxiliary unit, temperature, and potential of non-calibration range, enter [SPA].
 For the cell coefficient of non-calibration range, the reference value before or after the calibrated range is displayed.

Response from the instrument if it does not have the calibration data

RCC,***x,0,3**

Channel 1 digit 1: CH1 2: CH2

● Request command and response of the measurement value

Request command

R, MD, x [CR][LF]

Header

Channel
Name (Request of the measurement value)

Requests the measurement value of the specified channel.

Response from pH meter

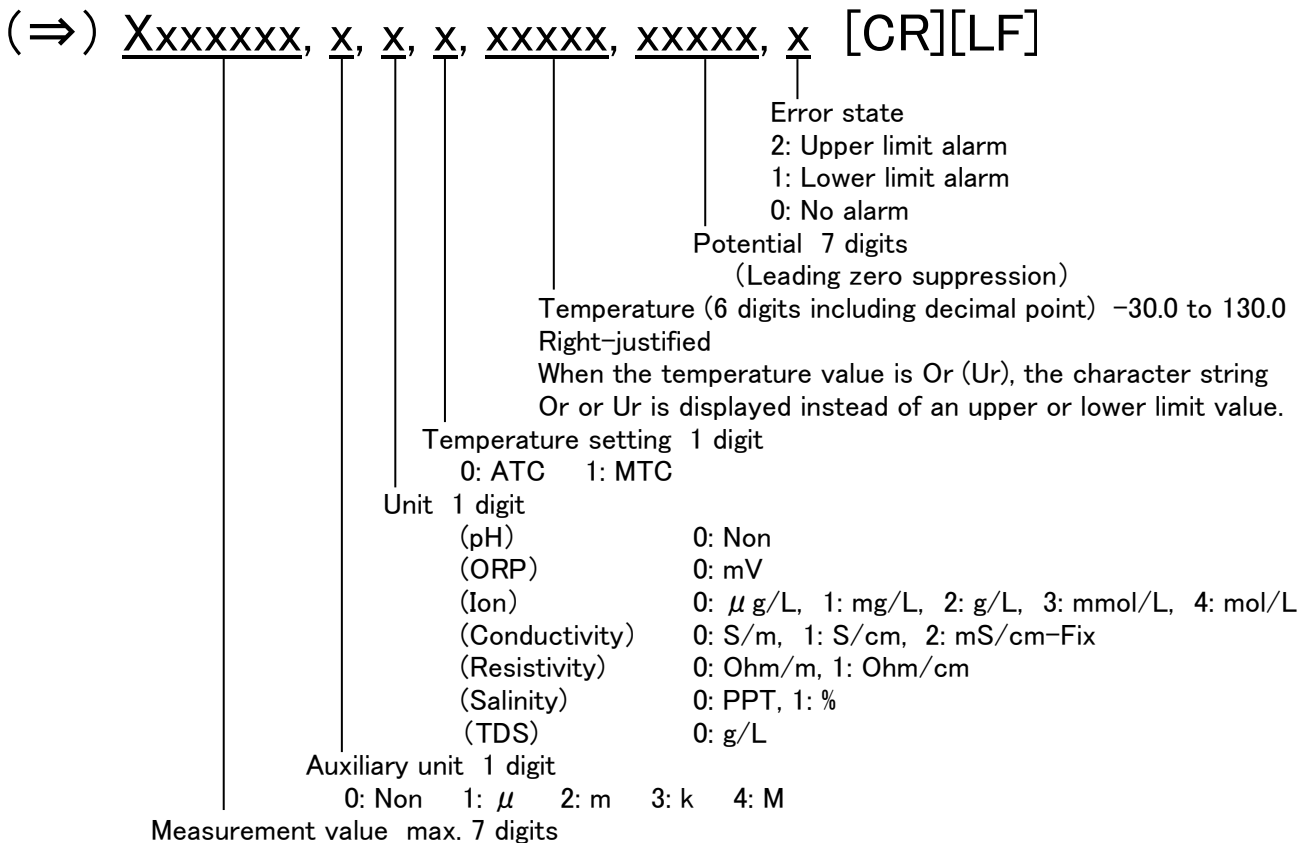
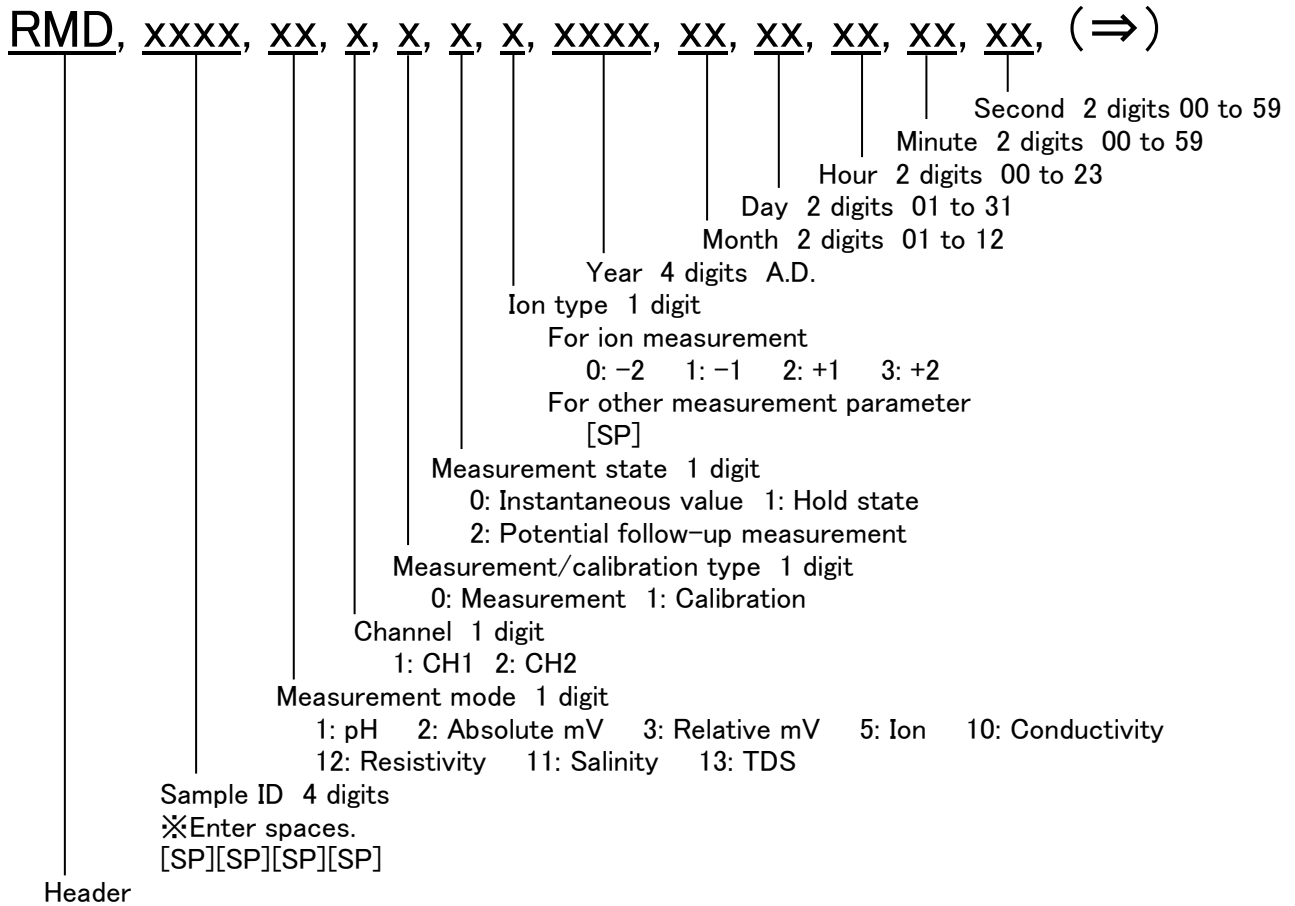

※Matches the displayed digit of each component to the display specifications.

pH	-2.000 to 16.000
ORP	-2000.0 to 2000.0
Ion	0.000 to 9999
Conductivity	0.000 to 1999
Resistivity	0.000 to 200.0
Salinity (%)	0.000 to 10.000
Salinity (PPT)	0.00 to 100.00
TDS	0.00 to 100

When the measurement value is Or (Ur),
the character string Or or Ur is displayed instead of upper and lower limit values.

●Request command and response of the clock data

Request command

R, OT [CR][LF]

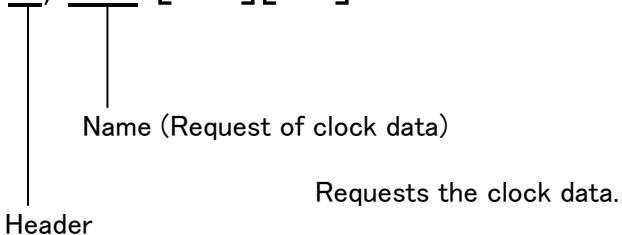

Response from pH meter

ROT, xxxx, xx, xx, xx, xx, xx [CR][LF]

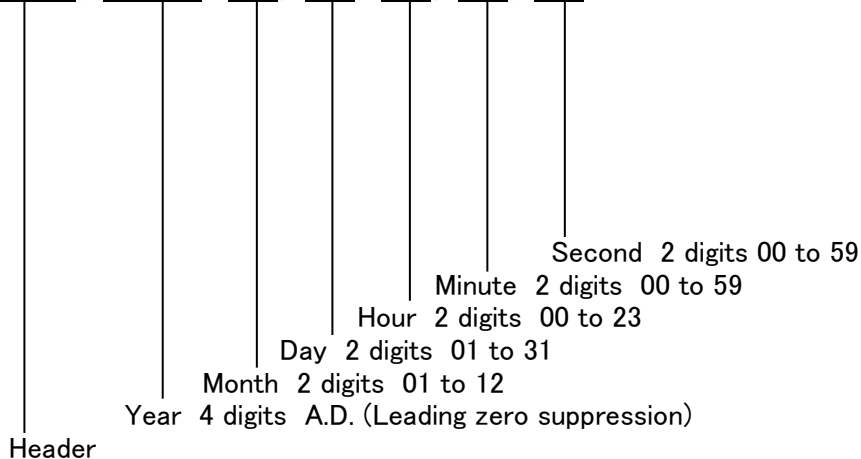

●Request command and response of the number of stored memories

Request command

R, MC [CR][LF]

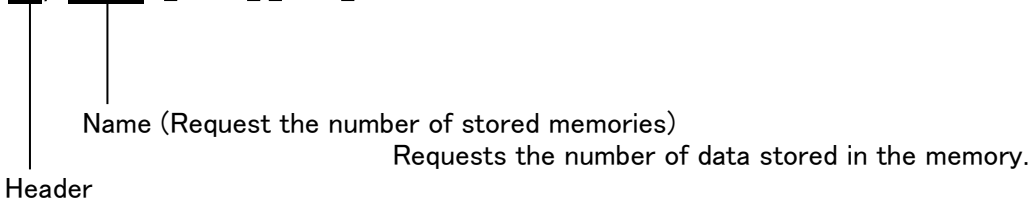

Response from pH meter

RMC, xxx [CR][LF]

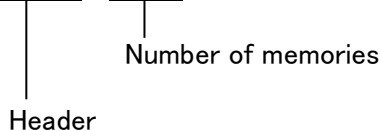

●Request command and response of memory data

Request command

R, MS, xxx, x [CR][LF]

Header

Name (Request of the measurement value)

Memory number

Channel (1 or 2)

Requests the memory data to be specified.

Response from pH meter

RMS, XXXX, XXXX, (⇒)

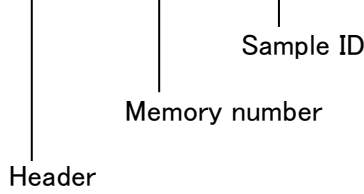

(⇒)

XX, X, X, X, X, XXXX, XX, XX, XX, XX, XX, XX, XXXXXXXX, (⇒)

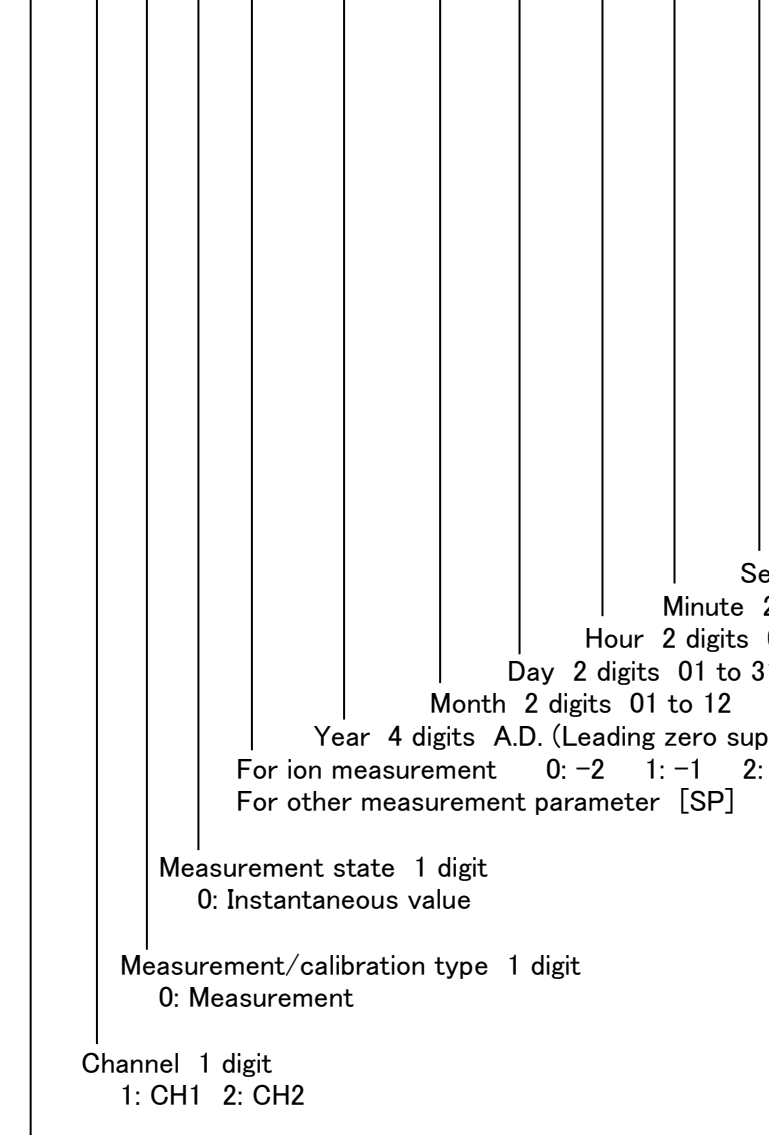

Measurement value max. 7 digits
 ※Matches the displayed digit of each component to the display specifications.

pH	-2.000 to 16.000
ORP	-2000.0 to 2000.0
Ion	0.000 to 9999
Conductivity	0.000 to 1999
Resistivity	0.000 to 200.0
Salinity (%)	0.000 to 10.000
Salinity (PPT)	0.00 to 100.00
TDS	0.00 to 100

When the temperature value is Or (Ur), the character string Or or Ur is displayed instead of an upper or lower limit value.

Second 2 digits 00 to 59

Minute 2 digits 00 to 59

Hour 2 digits 00 to 23

Day 2 digits 01 to 31

Month 2 digits 01 to 12

Year 4 digits A.D. (Leading zero suppression)

For ion measurement 0: -2 1: -1 2: +1 3: +2

For other measurement parameter [SP]

Measurement state 1 digit
 0: Instantaneous value

Measurement/calibration type 1 digit
 0: Measurement

Channel 1 digit
 1: CH1 2: CH2

Measurement mode 1 digit

1: pH 2: Absolute mV 3: Relative mV 5: Ion 10: Conductivity 12: Resistivity 11: Salinity 13: TDS

(⇒) x, x, x, XXXXXX, XXXXXXXX, x [CR][LF]

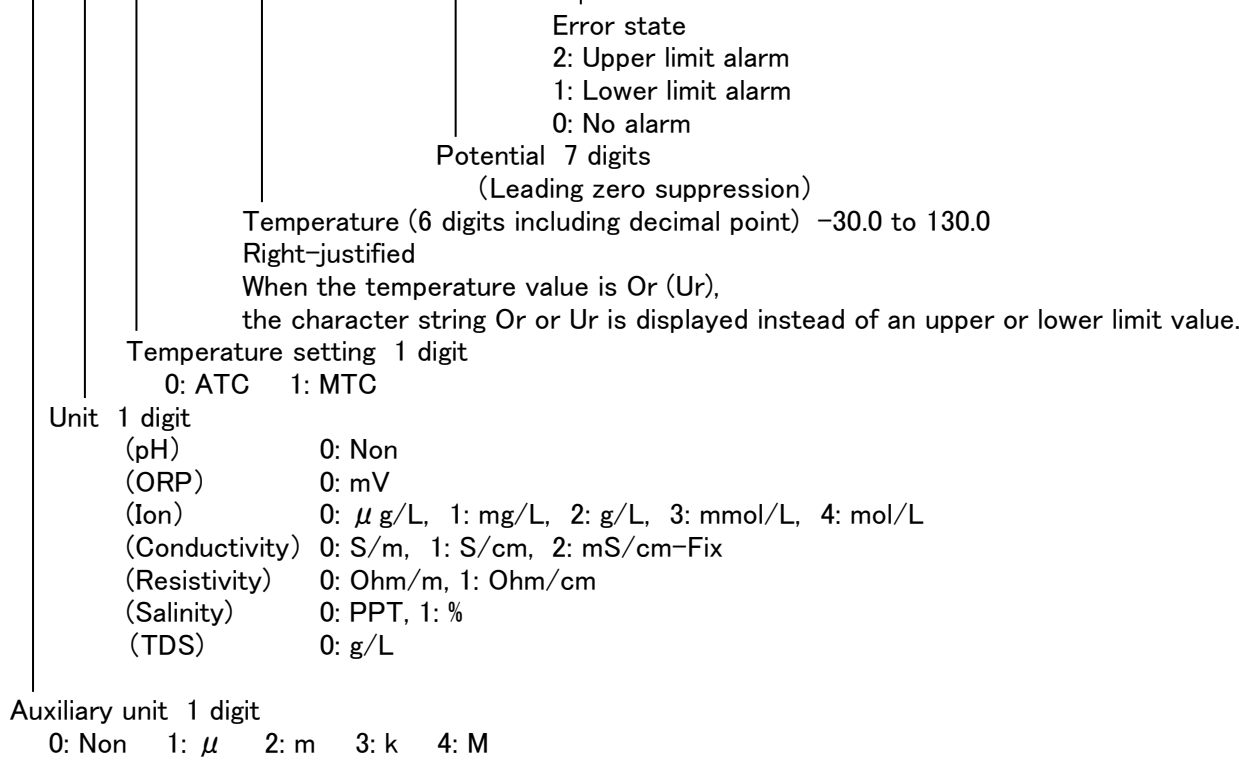

● Alarm inquiry command and response

Request command

R, AL, x, y [CR][LF]

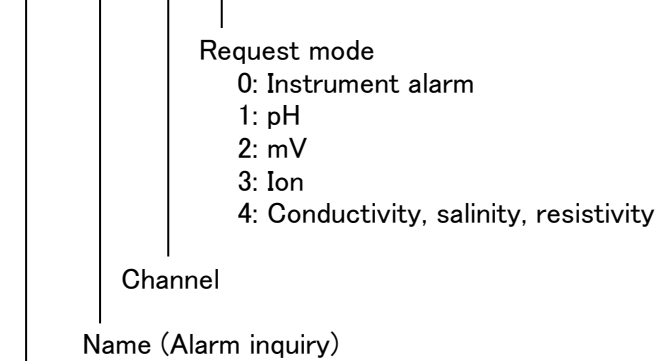

Header

Requests the alarm code in the instrument.

Response from pH meter

RAL, x, y, zzzzzzzz [CR][LF]

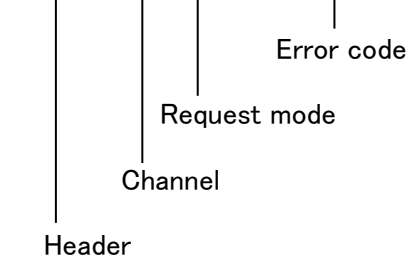

Error code

<u>zzzzzzzz</u>	Description
0x00000001	Internal memory error (instrument)
0x00000002	Lower battery error (instrument)
0x00000004	Electrode stability error (other than the instrument)
0x00000008	Asymmetry potential error (pH)
0x00000010	Sensitivity error (pH, ion)
0x00000020	Maximum calibration points exceeded (pH, ion)
0x00000040	Cannot identify standard solution (pH, conductivity)
0x00000080	Calibration interval error (pH)
0x00000100	Printer error (instrument)
0x00000200	Memory full (instrument)
0x00000400	Cell constant is out of range (conductivity)

● Alarm clear command and response

Request command

R, AR [CR][LF]

|

|

Name (Alarm clear)

Header

OK [CR][LF]

HORIBACODE:GZ0000438936
February, 2016 © 2016 HORIBA, Ltd.

pH/Water Quality Meter F-7X

High-spec Command Reference

■ Preface

This manual describes the communication command list of the pH/Water Quality Meters with serial communication function, F-72G/F-73G/F-74G/DS-72G.
The contents of this manual are subject to change without notice.

■ Caution

- Use the optional USB cable (part number: 3200373941) or serial cable (part number: 3014030151) to connect the instrument to a personal computer (referred to as PC in the rest of this document).
- Make sure that the transfer format used in the instrument and a PC are the same.
When different transfer format is used, a communication error occurs and the online mode does not start up, and as a result RS-232C communication cannot be performed. Also, when the transfer format is changed, turn OFF the power of the instrument and PC and then reboot them.

The transfer format of the instrument is as follows.

- Baud rate: 2400 bps
- Character length: 8 bits
- Parity: None
- Stop bit: 1 bit
- If you write the program for serial communication, at first, write the command to change the instrument to the online mode. By changing the instrument to the online mode, its operation keys except for  key are locked and it changes to serial communication mode.
If the instrument's power is turned OFF, reset the online mode.
- If the instrument does not receive the command or occurs any errors after it requested the data, add the waiting time of a few seconds before request the data again.
If the instrument received the data continuously, the instrument does not response.
- The instrument cannot be controlled by using the DCD, CTS, and DSR.
- It is necessary to switch RTS to ON to perform communication. Set it 2.4 V above.
- Pin assignment of the instrument and the external instrument are follows.

Instrument side (A connector MINI DIN 8 PIN)

- 2 TX
- 3 RX
- 4 CTS
- 5 COM

External instrument side (B connector DSUB 9 PIN)

- 2 TX (RX at an external instrument side)
- 3 RX (TX at an external instrument side)
- 5 COM
- 7 CTS (RTS at an external instrument side)

• Command function list (control)

Item	Command		Function
	Header	Name	
Online/Offline	C (Control)	OL	Changes between the online mode and the offline mode.
Potential follow-up stop		BR	Releases the hold state and returns to instantaneous value display state.
pH measurement mode		PH	Waits for the pH measurement.
mV measurement mode		MV	Waits for the ORP measurement mode result.
Ion measurement mode		IO	Waits for the ion measurement.
ORP measurement mode		OR	Waits for the ORP measurement.
Conductivity measurement mode		CO	Waits for the conductivity measurement.
Salinity measurement mode		SA	Waits for the salinity measurement.
Resistivity measurement mode		OH	Waits for the resistivity measurement.
TDS measurement mode		TD	Waits for the TDS measurement.
Measurement start		MS	Starts the interval memory when the interval memory is valid.
			Measures in the specified mode when the interval memory is invalid.
pH calibration start		CP	Starts the calibration and inspection before use in the pH measurement mode or hold state.
Ion calibration start		CI	Starts the ion calibration in the ion measurement mode or hold state.
Conductivity calibration start		CD	Starts the conductivity calibration in the conductivity measurement or hold state.
Salinity calibration start		CS	Starts the salinity calibration in the salinity measurement or hold state.
ORP calibration start		CR	Starts the ORP calibration in the ORP measurement or hold state.
Calibration clear		CC	Clears the calibration data in the measurement mode.
Data clear		DC	Clears all measurement data in the memory.
Data IN		IN	Starts the interval memory when the interval memory is valid.
			Stores the measurement memory when the interval memory is invalid.
Interval memory stop		CN	Stops the interval memory.
Display channel		CH	Toggles the display between 2-ch or 1-ch.
Hold condition	HC	Changes the hold condition.	

Changes the display corresponding to the command (Command ⇄ operation with touch panel)

To toggle from 2-ch mode to 1-ch mode, use each calibration start command or display channel command.

When the specified measurement is selected at a channel that is not displayed on the screen, the calibration can be performed without toggling the channel.

Response from pH meter

OK, zzzzz... [CR][LF]

or

ER, n, zzzzz... [CR][LF]

User ID (variable length from 1 to 50 characters)

Allowable code: Alpha-numeric characters, symbols (0x21 to 0x7E of ASCII code)

n = 1: A non-existent command was entered.

n = 2: The command was entered when the pH meter cannot accept it.

n = 3: An unacceptable number was entered in the command.

●Online/Offline command

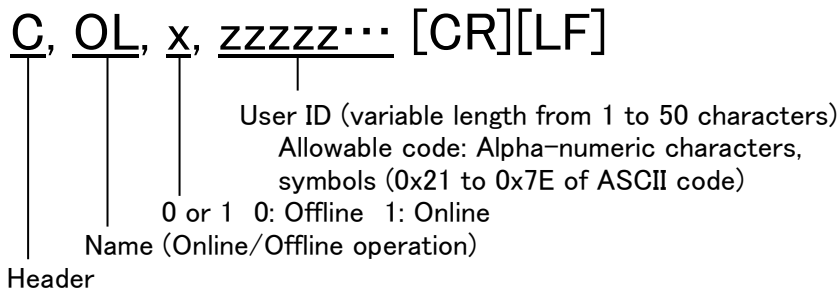

When the instrument accepts the online command,
it enters the online mode and the keys cannot be operated.

●Potential follow-up stop command

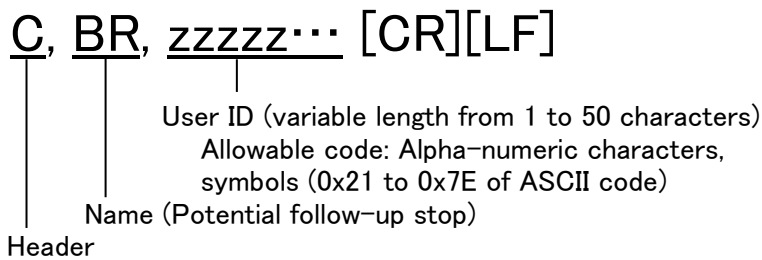

Releases the hold state and measurement state, then returns to instantaneous value display state.

●pH measurement mode command

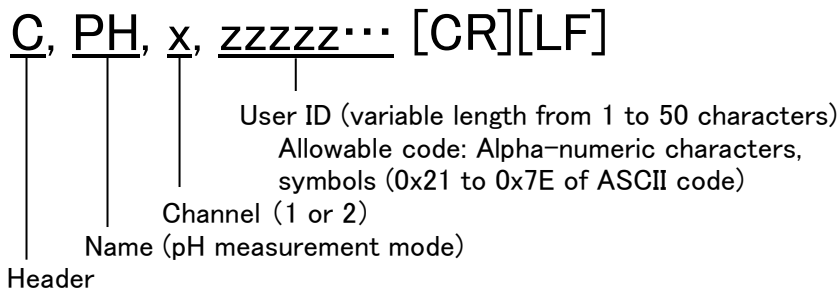

When the instrument is in the online mode, this is always valid.
Waits for the pH measurement.

●mV measurement mode command

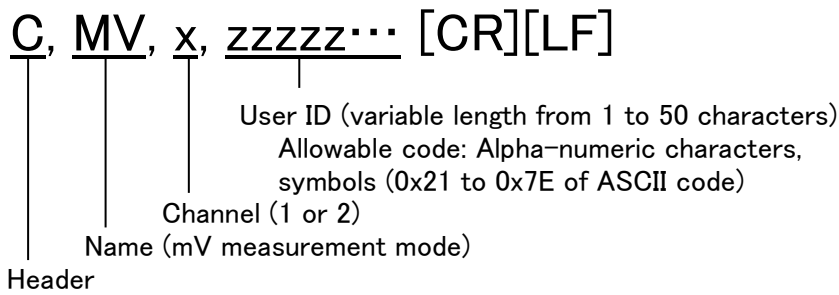

When the instrument is in the online mode, this is always valid. (*1)
Waits for the mV measurement mode result.

●Ion measurement mode command

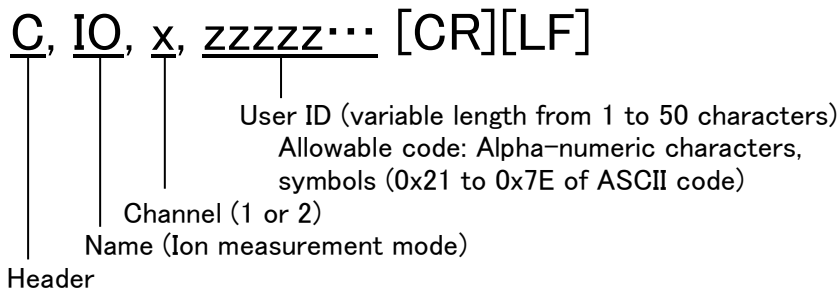

When the instrument is in the online mode, this is always valid. (*1)
Waits for the ion measurement.

●ORP measurement mode command

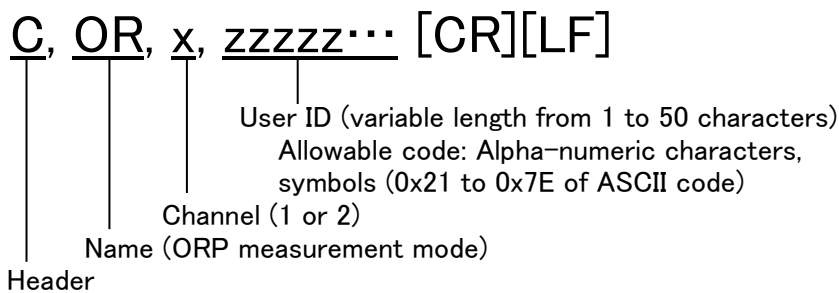

When the instrument is in the online mode, this is always valid. (*1)
Waits for the ORP measurement mode result.

● Conductivity measurement mode command

C, CO, zzzzz... [CR][LF]

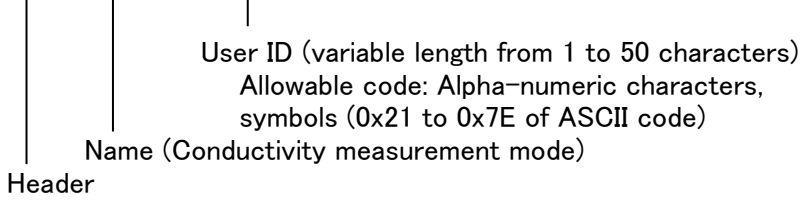

When the instrument is in the online mode, this is always valid. (*1)
Waits for the conductivity measurement.

*1: Except for the hold judgement

● Salinity measurement mode command

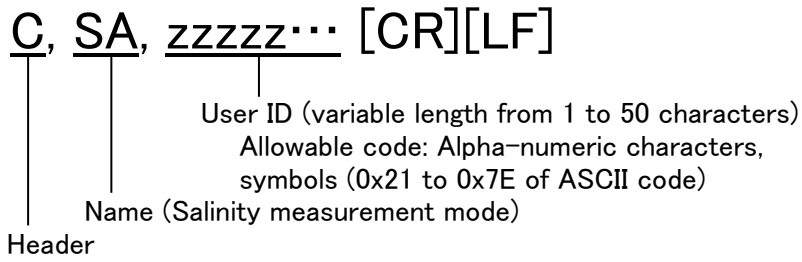

When the instrument is in the online mode, this is always valid. (*1)
Waits for the salinity measurement.

● Resistivity measurement mode command

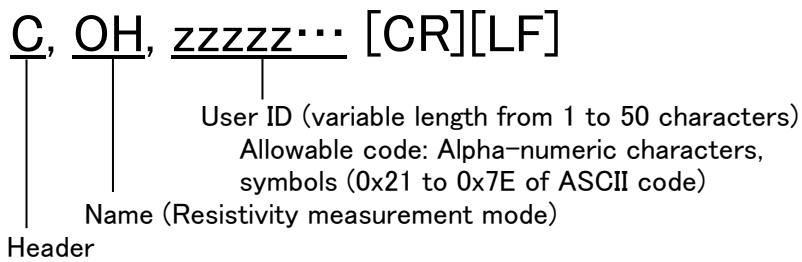

When the instrument is in the online mode, this is always valid. (*1)
Waits for the resistivity measurement.

● TDS measurement mode command

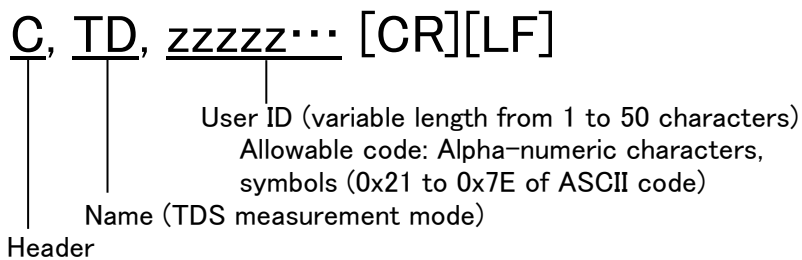

When the instrument is in the online mode, this is always valid. (*1)
Waits for the TDS measurement.

*1: Except for the hold judgement

● Measurement start command

C, MS, zzzzz... [CR][LF]

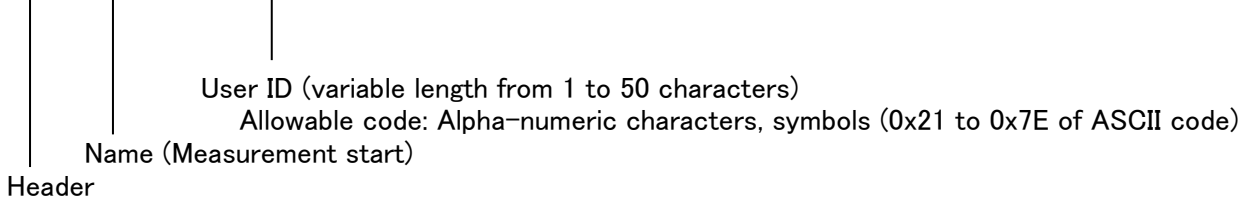

(When the interval memory is invalid) Waits for measurement in the specified mode (channel displayed on the screen, measurement mode).
(When the interval memory is valid) Starts the interval memory.

● pH calibration start command

C, CP, x, xxxxxx, zzzzz... [CR][LF]

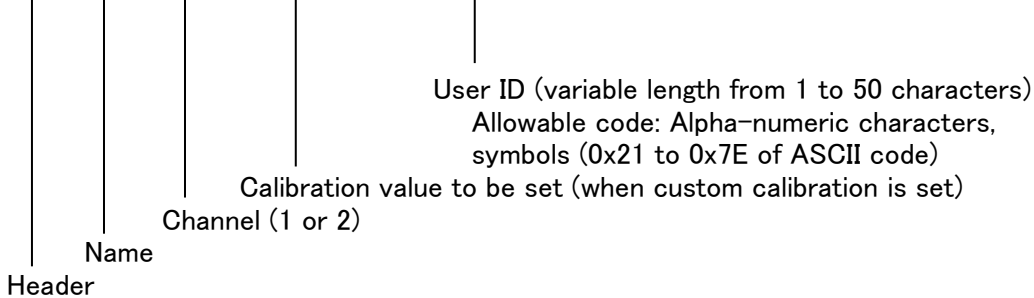

Starts the calibration and inspection before use when waiting for pH measurement or hold state. Even when the setting is other than the custom calibration, it is necessary to enter the calibration value (It will not be used.).

Setting range of calibration value (fixed length)

Specified by three decimal places.

[SP]0.000 to 14.000

● Ion calibration start command

C, CI, x, yyyyy, z, zzzzz... [CR][LF]

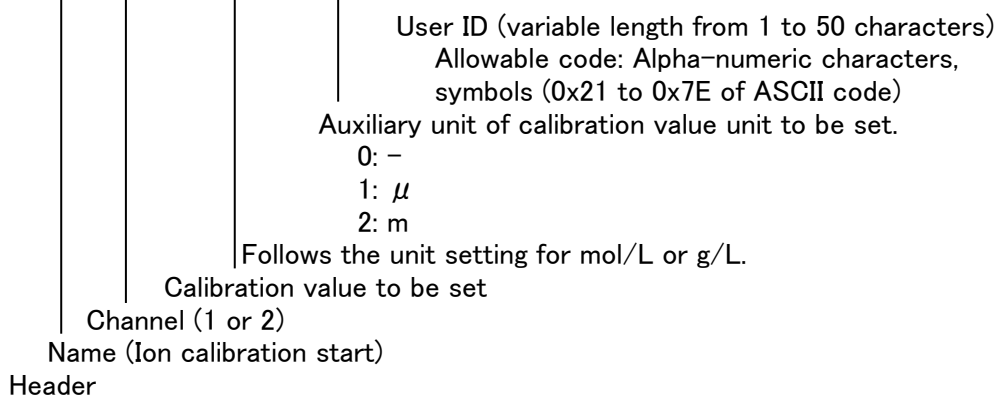

Starts the ion calibration when waiting for ion measurement or hold state. When the calibration start command is transmitted from the measurement mode, the calibration value is overwritten by the previous calibration value of same standard solution.

Setting range of calibration value (fixed length)

- 0.001 to 9.999
- 10.00 to 99.99
- 100.0 to 999.9
- 1000 to 9999

●Conductivity cell constant calibration start command

C, CD, yyyyy, z, zzzzz... [CR][LF]

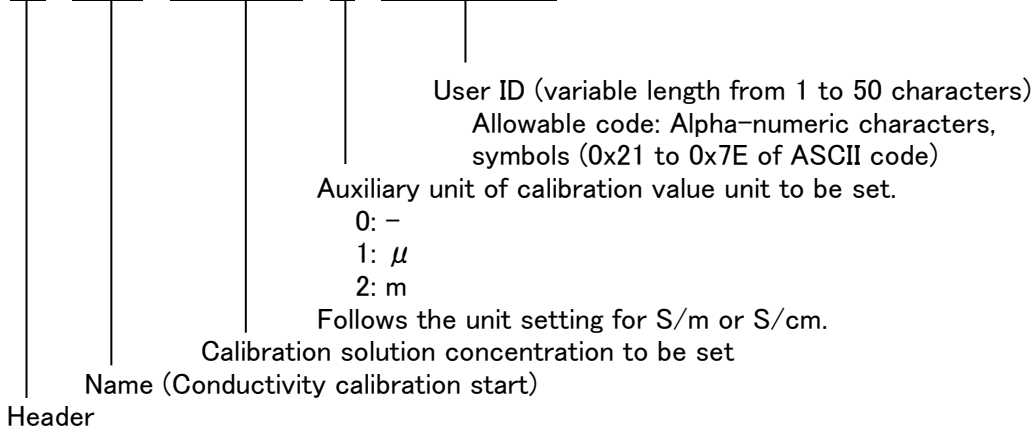

Starts the conductivity calibration when waiting for conductivity calibration or hold state.

Setting range of calibration value (fixed length)

μ S/m	[SP][SP]1.0 to 999.9
mS/m	0.001 to 199.9
S/m	0.001 to 199.9
μ S/cm	0.010 to 1999
mS/cm	0.001 to 199.9
S/cm	0.001 to 1.999
mS/cmFIX	0.001 to 999.9

●Salinity calibration start command

C, CS, xxxxx, zzzzz... [CR][LF]

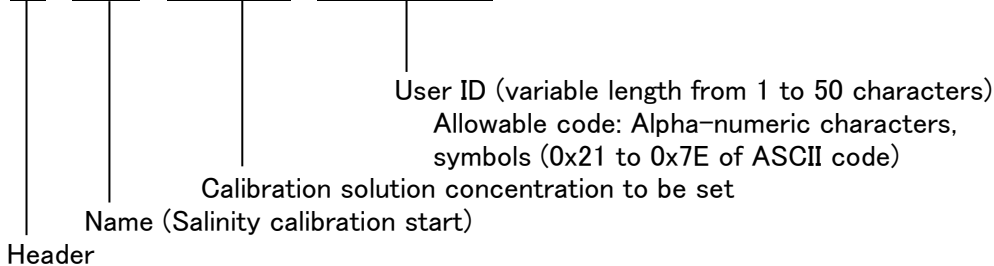

Starts the salinity calibration when waiting for salinity calibration or hold state.

Setting range of calibration value

PPT	[SP]0.01 to 80.00
%	0.001 to 8.000

●ORP calibration start command

C, CR, x, yyyyyy, zzzzz... [CR][LF]

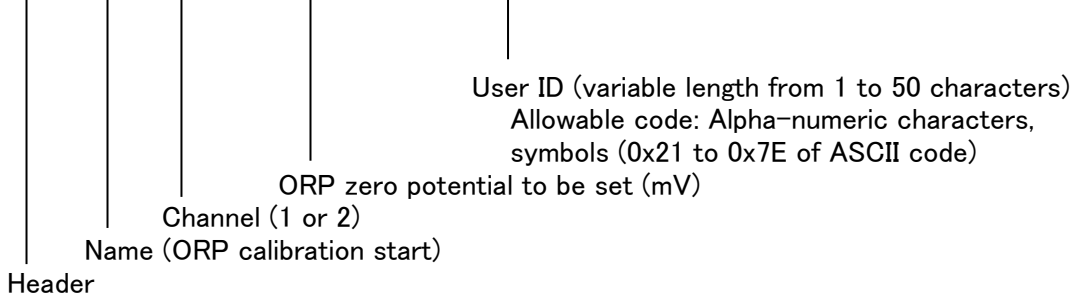

Starts the ORP calibration when waiting for ORP calibration or hold state.

Setting range of calibration value (fixed length)

-1999.9 to [SP]1999.9 (mV)

● Calibration clear command

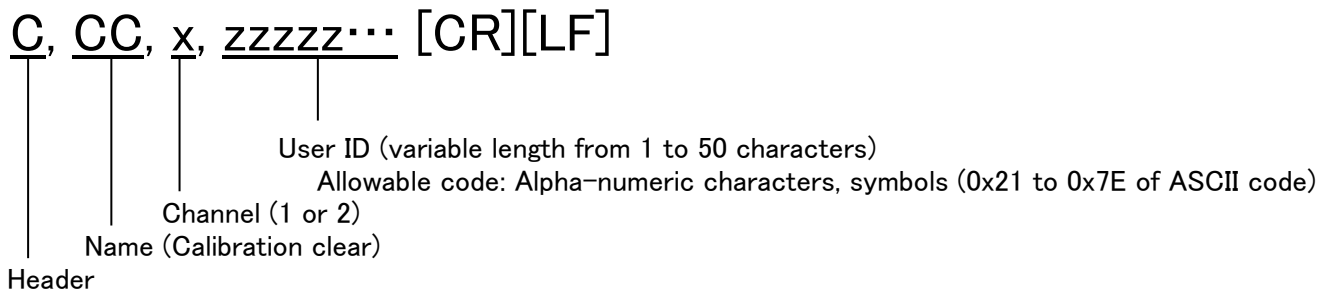

Clears the calibration data in the measurement mode.

● Data IN command

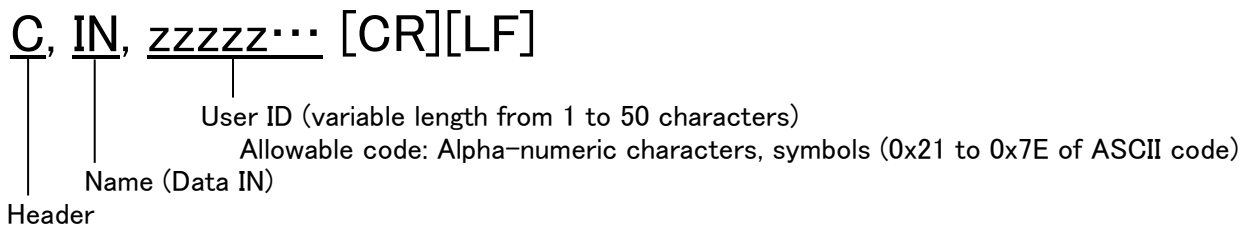

(When the interval memory is valid) Starts the interval memory.

(When the interval memory is invalid) Stores the measurement data.

ER, 2 is returned when the data memory is full.

●Interval memory stop command

C, CN, zzzzz... [CR][LF]

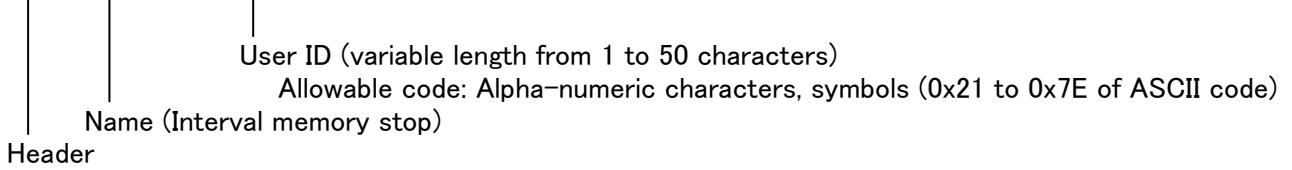

This is valid during interval memory.
Stops the interval memory.

●Display channel command

C, CH, x, zzzzz... [CR][LF]

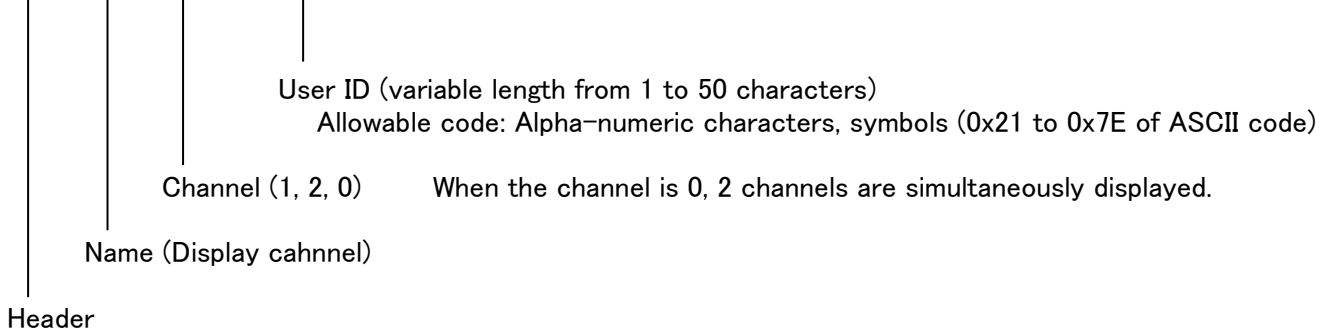

Changes the measurement channel displayed on the screen.

When selecting 2-channel display:

- Does not show the 1-channel display with the measurement mode change command.
- Shows the 1-channel display with the calibration start command.

●Hold condition setting command

C, HC, x, zzzzz... [CR][LF]

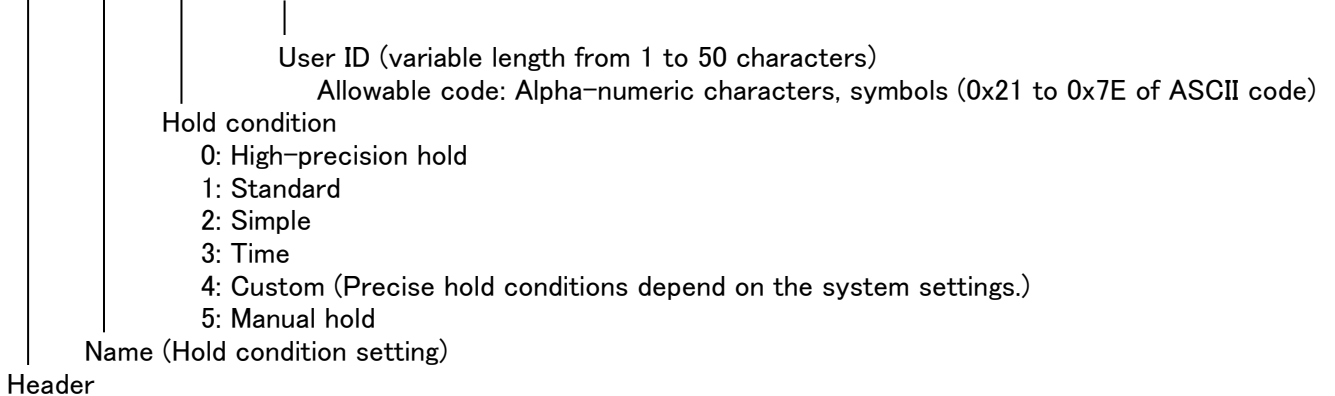

Sets the hold condition.

ER, 2 is returned during hold judgement.

ER, 2 is returned in every mode except the measurement mode (for example, calibration mode).

• Command function list (Request data)

Item	Command		Function
	Header	Name	
Request of the calibration history of pH	R (Request Data)	PC	Gets the latest calibration history of pH.
Request of the calibration history of ion		IC	Gets the latest calibration history of ion.
Request of the calibration history of conductivity		CC	Gets the latest calibration history of conductivity.
Requests the salinity calibration history		SC	Gets the calibration history of salinity.
Requests the ORP calibration history		OC	Gets the calibration history of ORP.
Request of the measurement value		MD	Gets the measurement value of specified channel.
Request of the clock data		OT	Gets the clock data.
Request of the number of stored memories		MC	Gets the number of data stored in the memory.
Request of memory data		MS	Gets the memory data to be specified.
Alarm inquiry		AL	Gets the alarm code in the instrument.
Clear alarm		AR	Clears the alarm code in the instrument.

Response from pH meter

When it is OK:

Described for each command

or

ER, n, zzzzz... [CR][LF]

User ID (variable length from 1 to 50 characters)

Allowable code: Alpha-numeric characters, symbols (0x21 to 0x7E of ASCII code)

n = 1: A non-existent command was entered.

n = 2: The command was entered when the pH meter cannot accept it.

n = 3: An unacceptable number was entered in the command.

●Request command and response of the calibration history of pH

Request command

R, PC, x, zzzzz... [CR][LF]

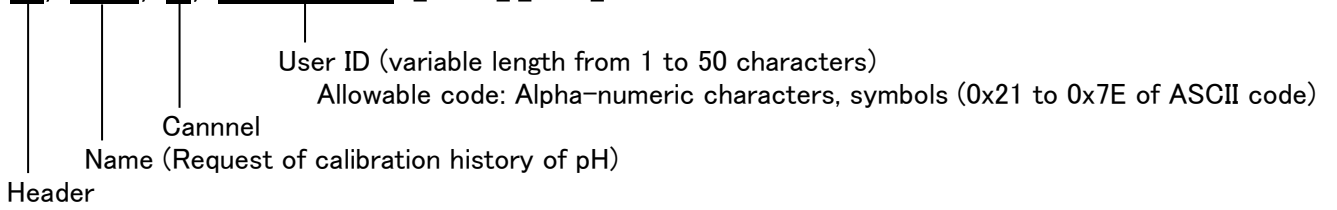

Response from pH meter

RPC, XXXXXXXXXXXX, X, X, X, X, XXXXXX, X, (⇒)

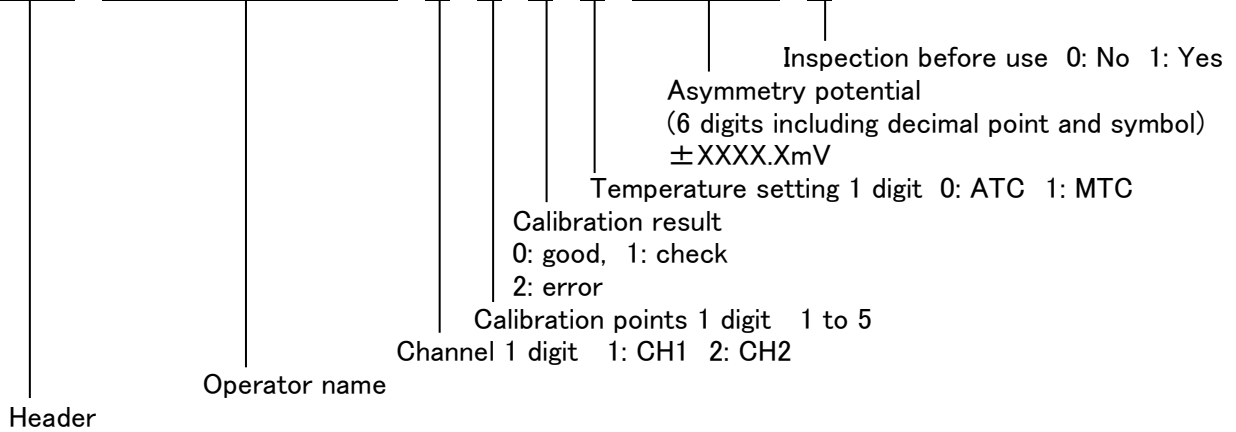

(⇒) XXXX, XX, XX, XX, XX, XX, (⇒)

Calibration date
Year 4 digits A.D.
Month 2 digits 01 to 12
Day 2 digits -1 to 31
Hour 2 digits 00 to 23
Minute 2 digits 00 to 59
Second 2 digits 00 to 59

Slope (sensitivity) (5 digits including decimal point and symbol)
*For 1-point or 2-point calibration, the potential is output as the 1st or 2nd calibration data.

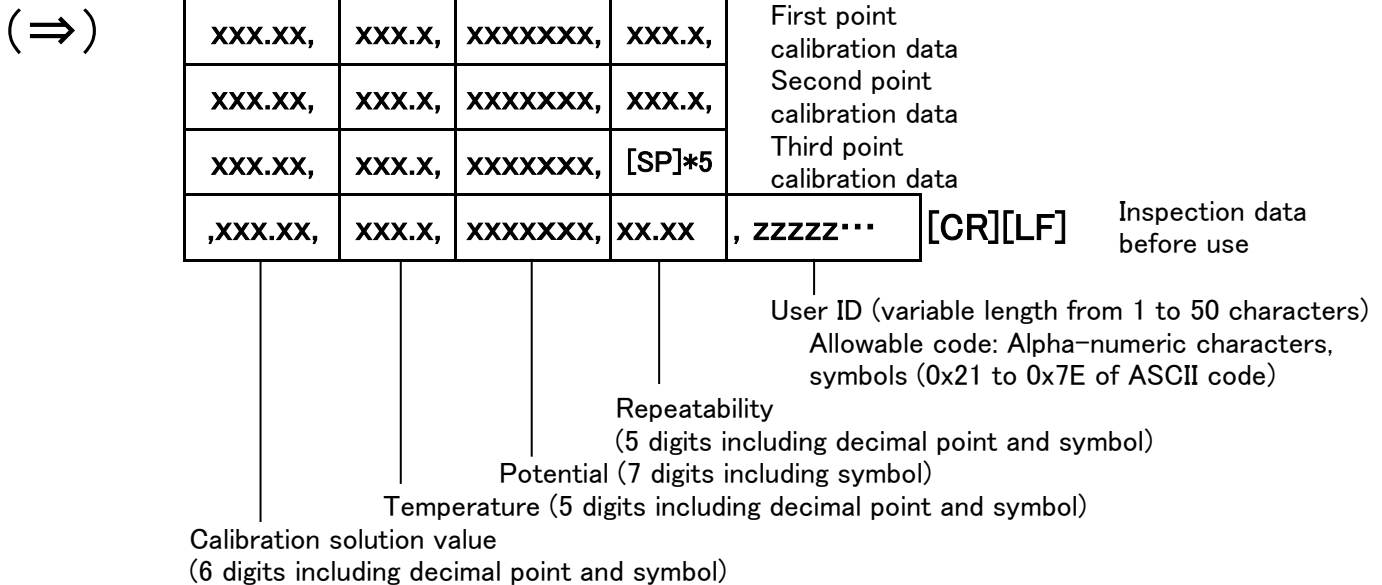

Response from the instrument if it does not have the calibration data

RPC,***x,0,3, zzzzz...**

Display format is fixed. If no data exist, [SP] is displayed.

The number of transmitted calibration data is the number of calibration points.

Displayed calibration date and time is the latest calibration date and time.

When there are two or more calibration points,

slope data is displayed and the slope data of the third point is a space.

If an inspection is carried out before use, its data will be transmitted after the calibration data is forwarded.

Slope data

For the slope data, the calibration efficiency, A X 100, between each point is output.

When it exceeds 999.9 or is a negative value, [SP][SP][SP][SP][SP] is output.

●Request command and response of the calibration history of ion

Request command

R, IC, x, zzzzz... [CR][LF]

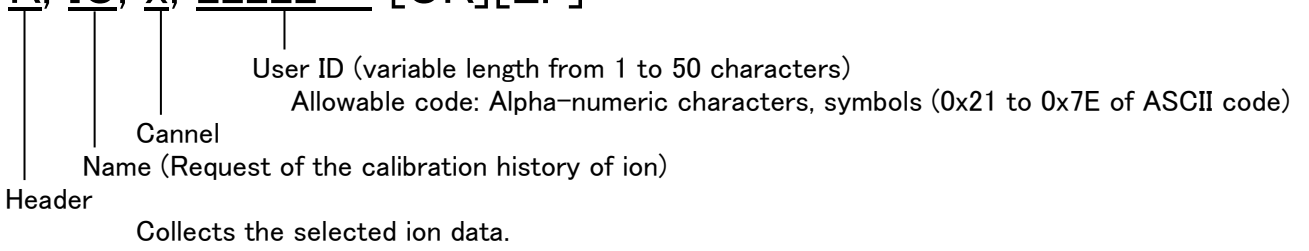

Response from pH meter

RIC, XXXXXXXXXXXX, X, XX, X, X, X, XXXXXX, X, (⇒)

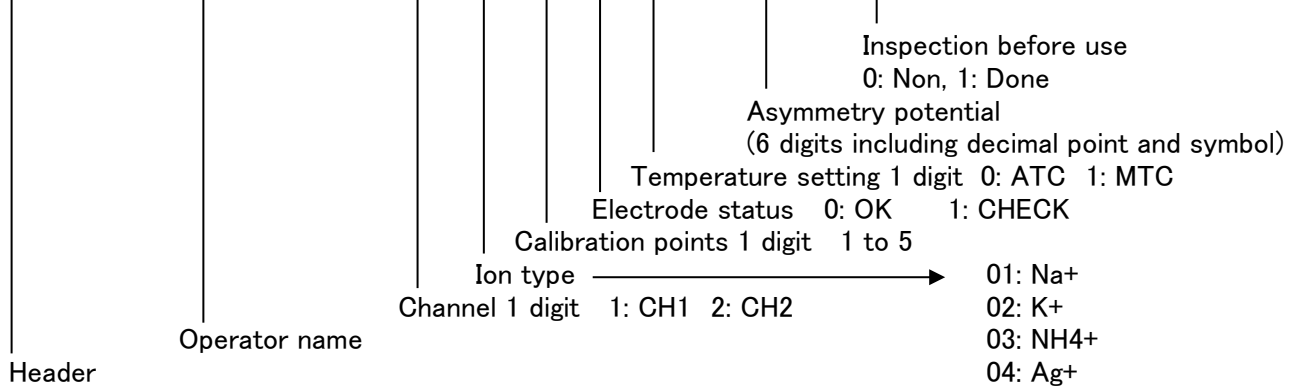

- 01: Na+
- 02: K+
- 03: NH4+
- 04: Ag+
- 05: X+
- 06: CN-
- 07: Cl-
- 08: I-
- 09: Br-
- 10: SCN-
- 11: F-
- 12: NO3-
- 13: X-
- 14: Cu2+
- 15: Cd2+
- 16: Pb2+
- 17: Ca2+
- 18: X2+
- 19: S2-
- 20: X2-

(⇒) XXXX,XX,XX,XX,XX,XX, (⇒)

Calibration date
 Year 4 digits A.D.
 Month 2 digits 01 to 12
 Day 2 digits -1 to 31
 Hour 2 digits 00 to 23
 Minute 2 digits 00 to 59
 Second 2 digits 00 to 59

(⇒)

XXXXX	X,X	XXXXX	XXXXXXXX	XXXXXX	. . .	, zzzzz . . .
-------	-----	-------	----------	--------	-------	---------------

 [CR][LF]

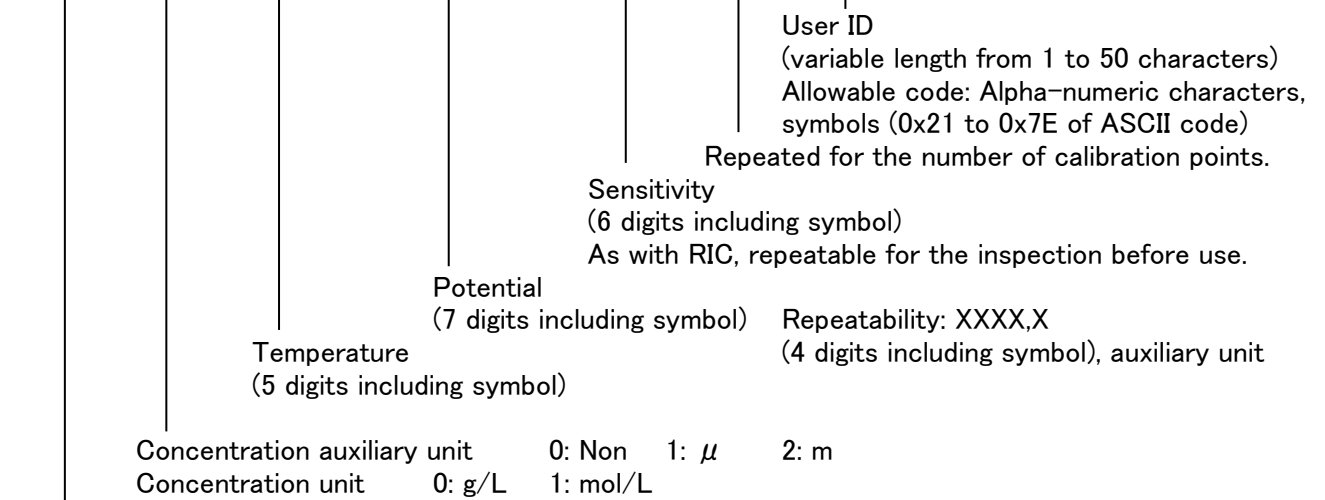

Calibration solution concentration (5 digits including symbol)
 (5 digits including symbol)
0.001 to 9.999
10.00 to 99.99
100.0 to 999.9
1000 to 9999

Response from the instrument if it does not have the calibration data

RIC,***x,0,0,3, zzzzz'**

●Request command and response of the calibration history of conductivity

Request command

R, CC, zzzzz... [CR][LF]

Header

User ID (variable length from 1 to 50 characters)

Allowable code: Alpha-numeric characters, symbols (0x21 to 0x7E of ASCII code)

Name (Request of the calibration history of conductivity)

Response from pH meter

RCC, xxxxxxxxxxxx; x, x, x, x, (⇒)

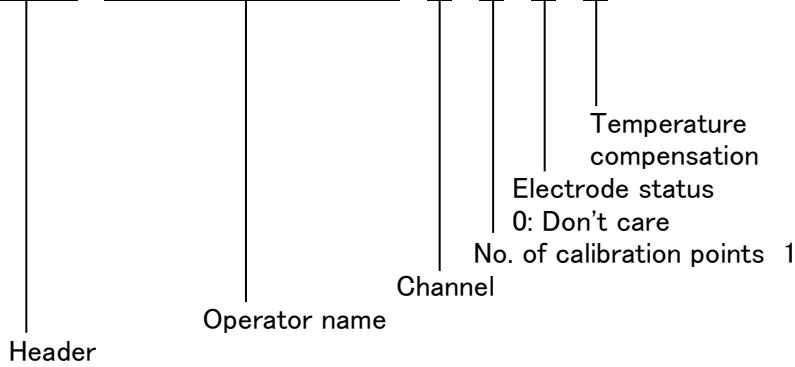

(⇒) xxxx,xx,xx,xx,xx,xx, (⇒)

Calibration date
 Year 4 digits A.D.
 Month 2 digits 01 to 12
 Day 2 digits -1 to 31
 Hour 2 digits 00 to 23
 Minute 2 digits 00 to 59
 Second 2 digits 00 to 59

(⇒)

xxxx,	xxxxxx,	x,	x,	xxxxxx,	x.xxx,	
	xxxxxx,	x,	x,	xxxxxx,	x.xxx,	
	xxxxxx,	x,	x,	xxxxxx,	x.xxx,	
	xxxxxx,	x,	x,	xxxxxx,	x.xxx,	
	xxxxxx,	x,	x,	xxxxxx,	x.xxx,	zzzzz... [CR][LF]

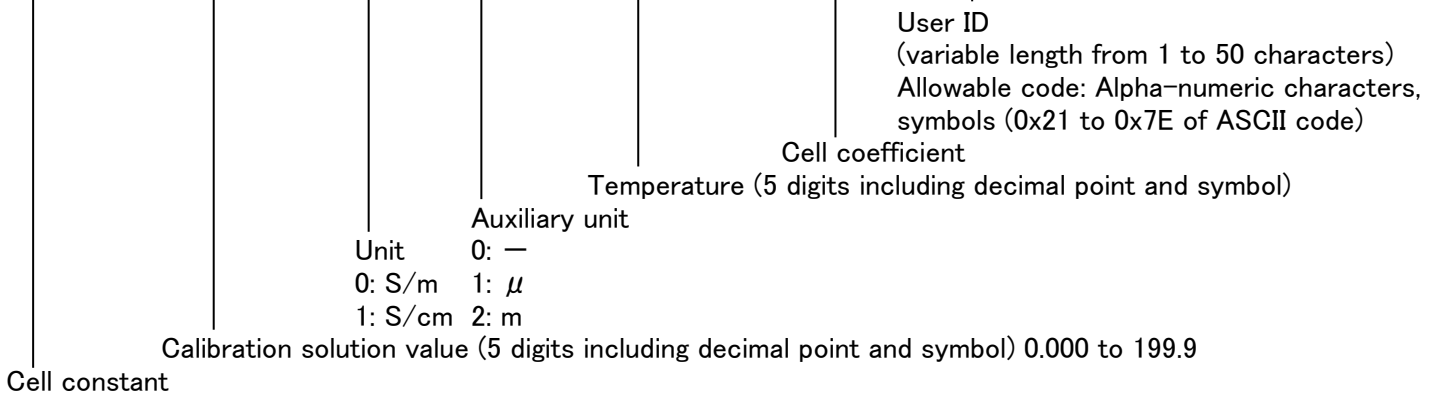

Displayed calibration date and time is the latest calibration date and time.
 For the calibration solution concentration, unit, auxiliary unit, temperature, and potential of non-calibration range, enter [SP].
 For the cell coefficient of non-calibration range, the reference value before or after the calibrated range is displayed.

Response from the instrument if it does not have the calibration data

RCC,*****x,0,3, zzzzz···

●Request command and response of the calibration history of salinity

Request command

R, SC, zzzzz... [CR][LF]

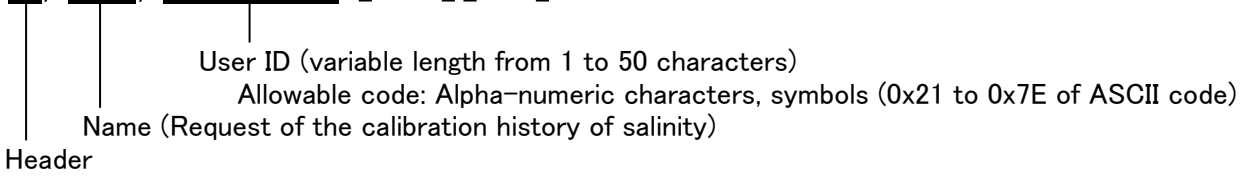

Response from pH meter

RSC, xxxxxxxxxxxx, x, x, x, x, (⇒)

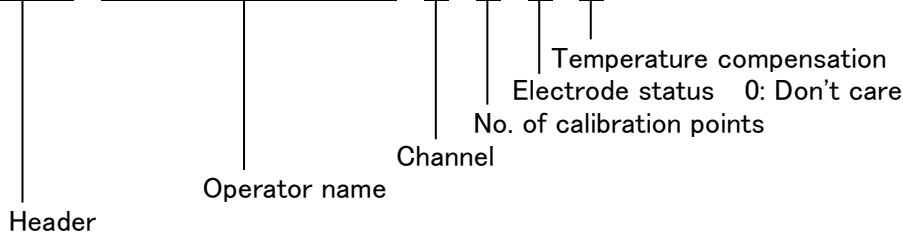

(⇒) xxxx,xx,xx,xx,xx,xx, (⇒)

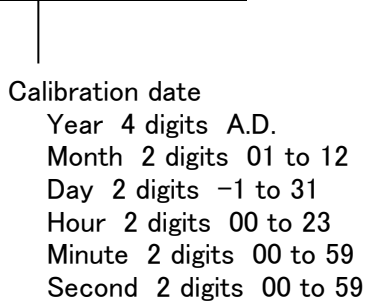

(⇒)

xxxxx, xxxxx, zzzzz... [CR][LF]

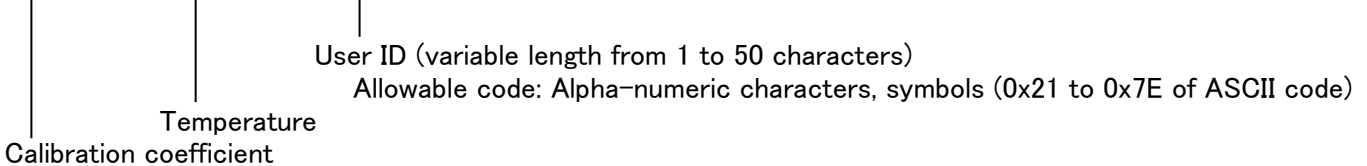

Response from the instrument if it does not have the calibration data

RSC,*****x,0,3, zzzzz...

Displayed calibration date and time is the latest calibration date and time.

●Request command and response of the calibration history of ORP

Request command

R, OC, x, zzzzz... [CR][LF]

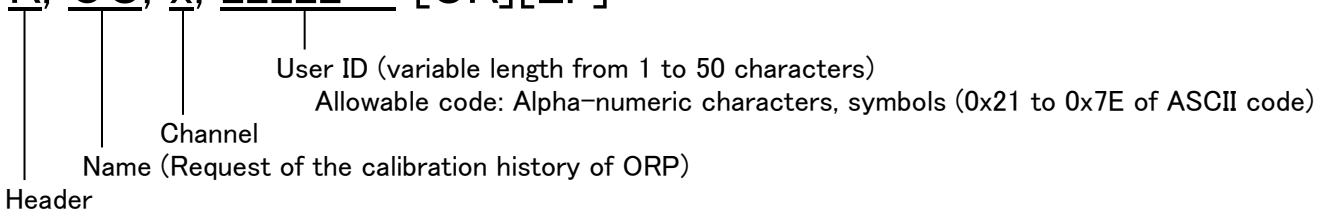

Response from pH meter

ROC, xxxxxxxxxxxxx, x, x, x, x, (⇒)

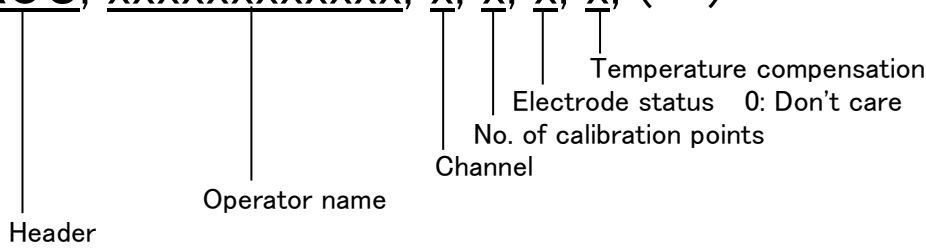

(⇒) xxxx,xx,xx,xx,xx,xx, (⇒)

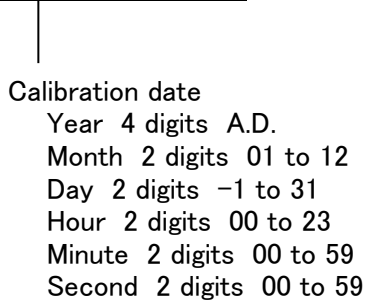

(⇒)

xxxxx, xxxxx, zzzzz... [CR][LF]

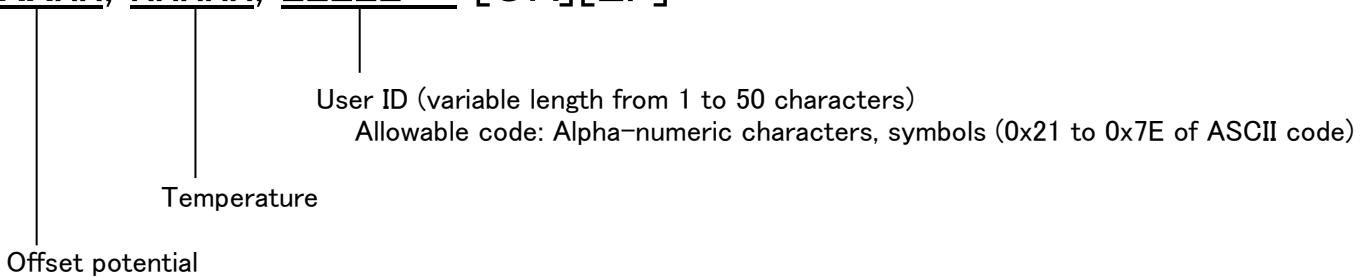

Response from the instrument if it does not have the calibration data

ROC,*****x,0,3, zzzzz...

● Request command and response of the measurement value

Request command

R, MD, x, zzzzz... [CR][LF]

Header

Channel
Name (Request of the measurement value)

User ID (variable length from 1 to 50 characters)
Allowable code: Alpha-numeric characters, symbols (0x21 to 0x7E of ASCII code)

Requests the measurement value of the specified channel.

Response from pH meter

RMD, XXXXXXXXXXXX, XXXXXXXXXXXX, XX, X, X, X, XX, (⇒)

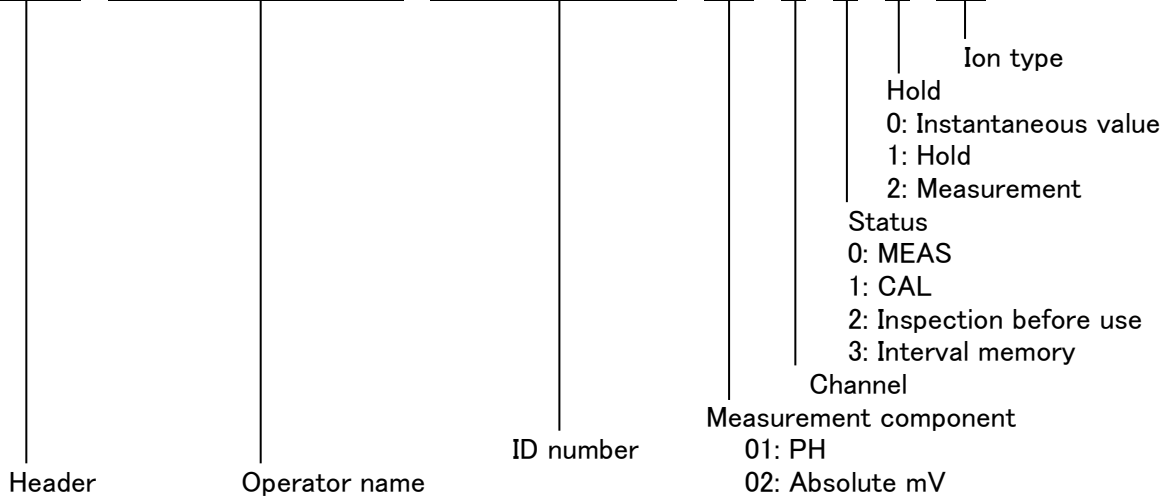

(⇒) XXXX,XX,XX,XX,XX,XX, (⇒)

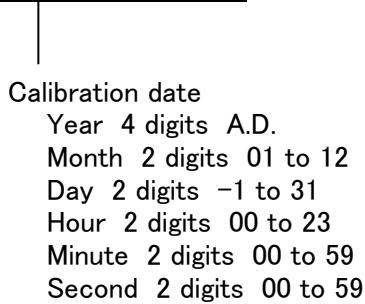

(⇒)

XXXXXXXX, X, X, X, XXXXX, XXXXXXX, X, zzzzz... [CR][LF]

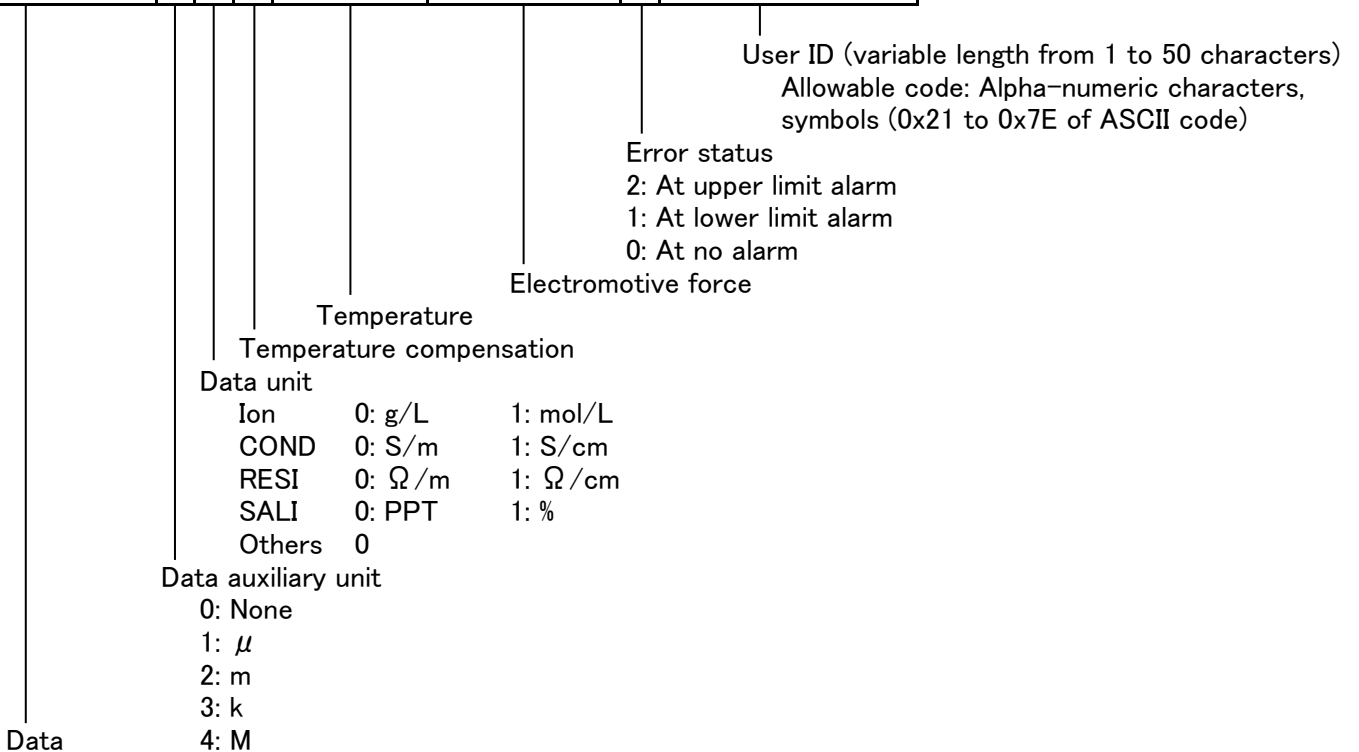

●Request command and response of the clock data

Request command

R, OT, zzzzz... [CR][LF]

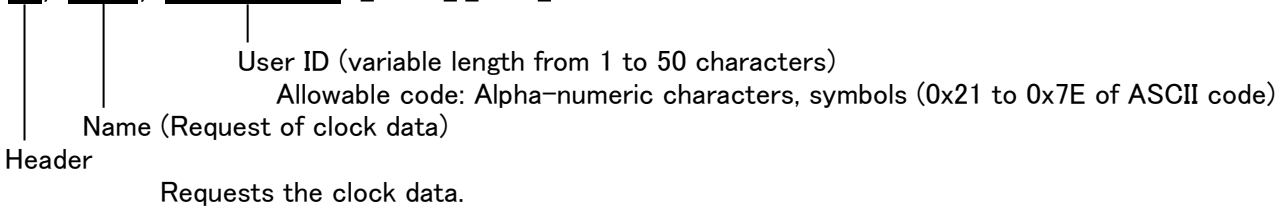

Response from pH meter

ROT, xxxx, xx, xx, xx, xx, xx, zzzzz... [CR][LF]

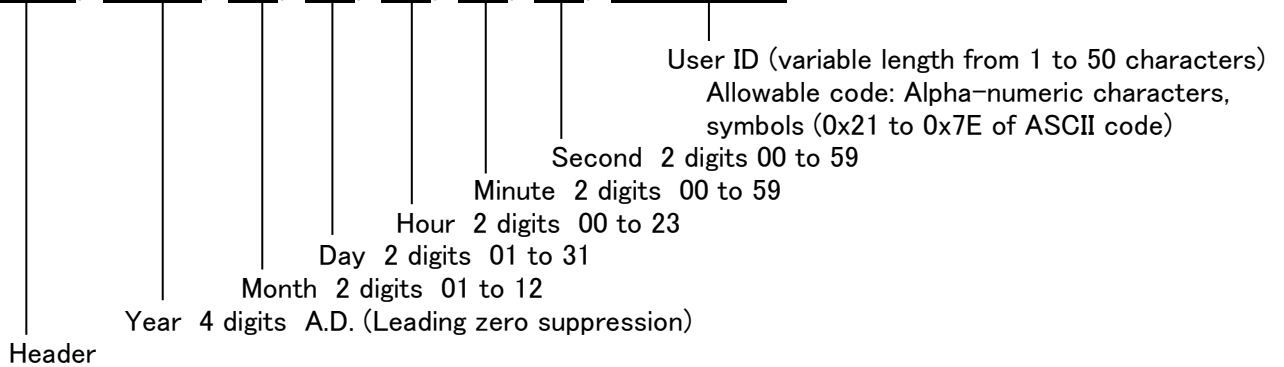

●Write command of the clock data

R, TO, xxxx, xx, xx, xx, xx, xx, zzzzz... [CR][LF]

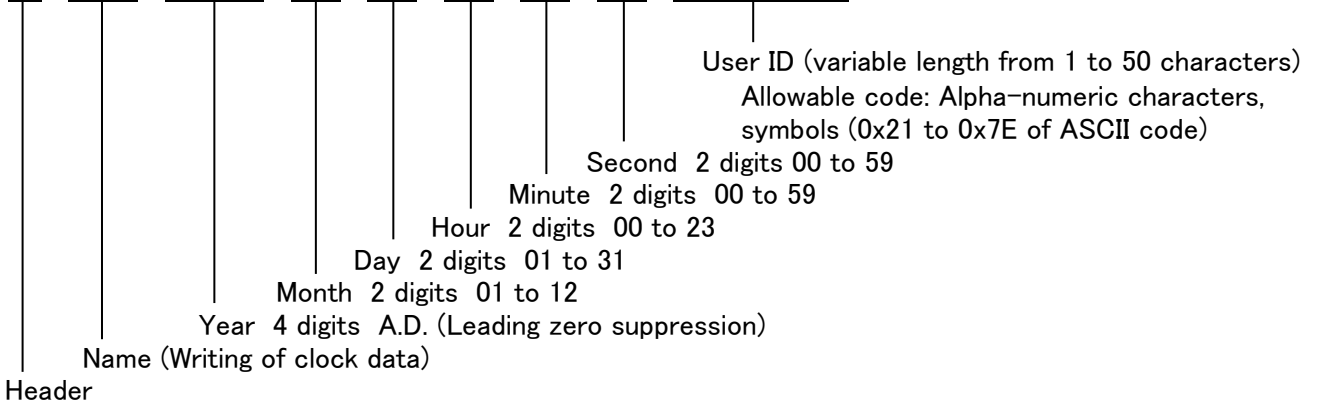

Writes the clock data.

An error response is returned when the a date and time that cannot be set are entered.

●Request command and response of the number of stored memories

Request command

R, MC, zzzzz... [CR][LF]

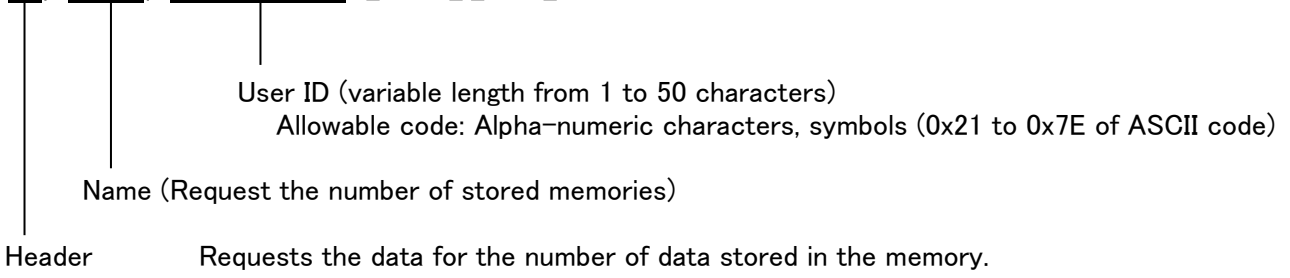

Response from pH meter

RMC, xxxx, zzzzz... [CR][LF]

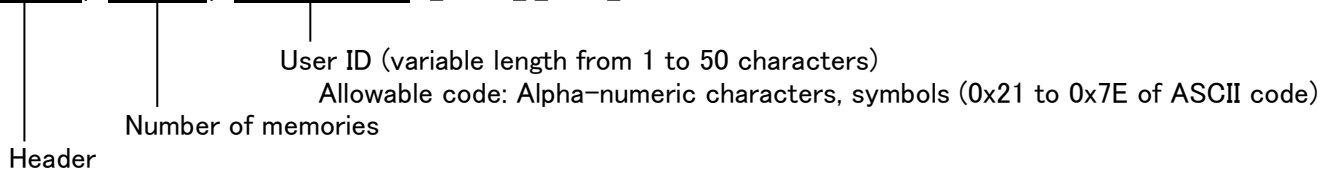

●Request command and response of memory data

Request command

R, MS, xxxx, zzzzz... [CR][LF]

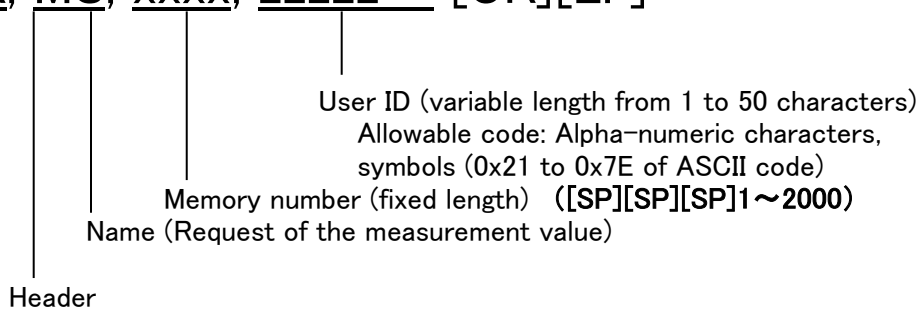

Requests the memory data to be specified.

Response from pH meter

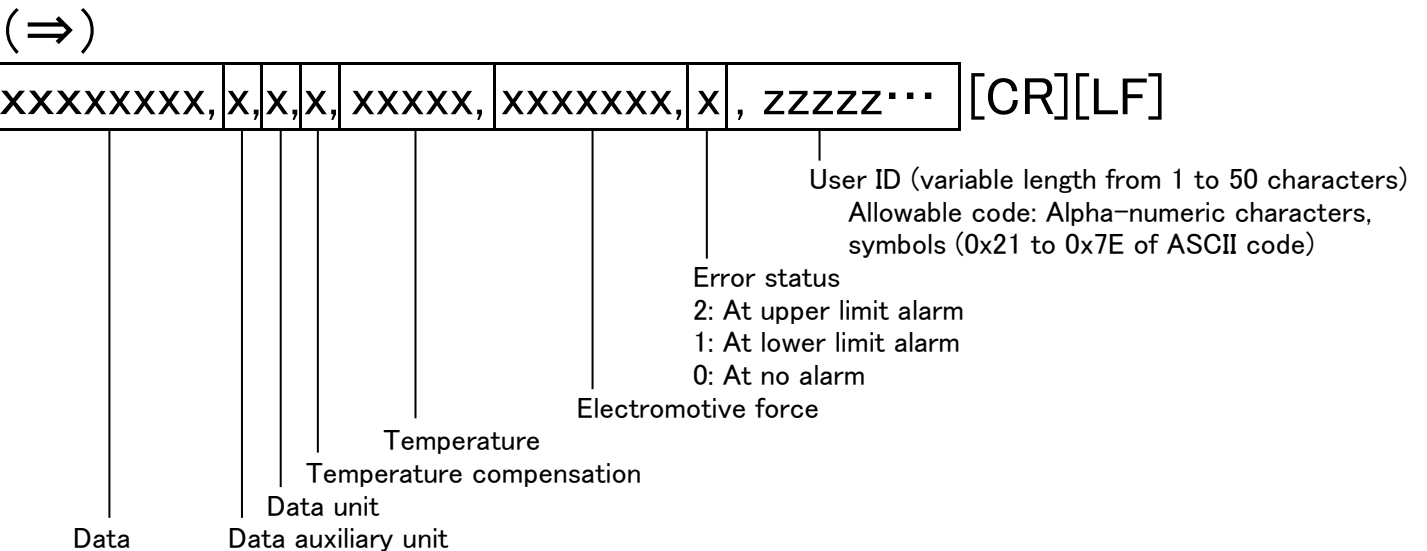
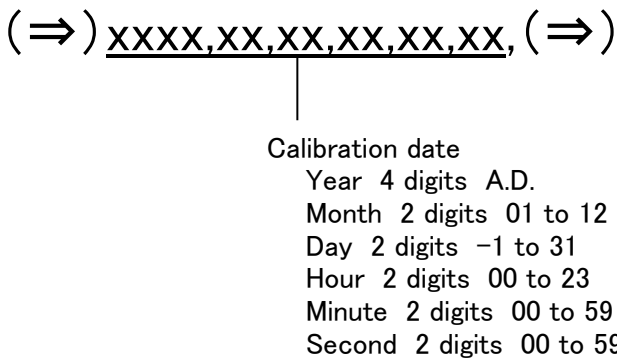
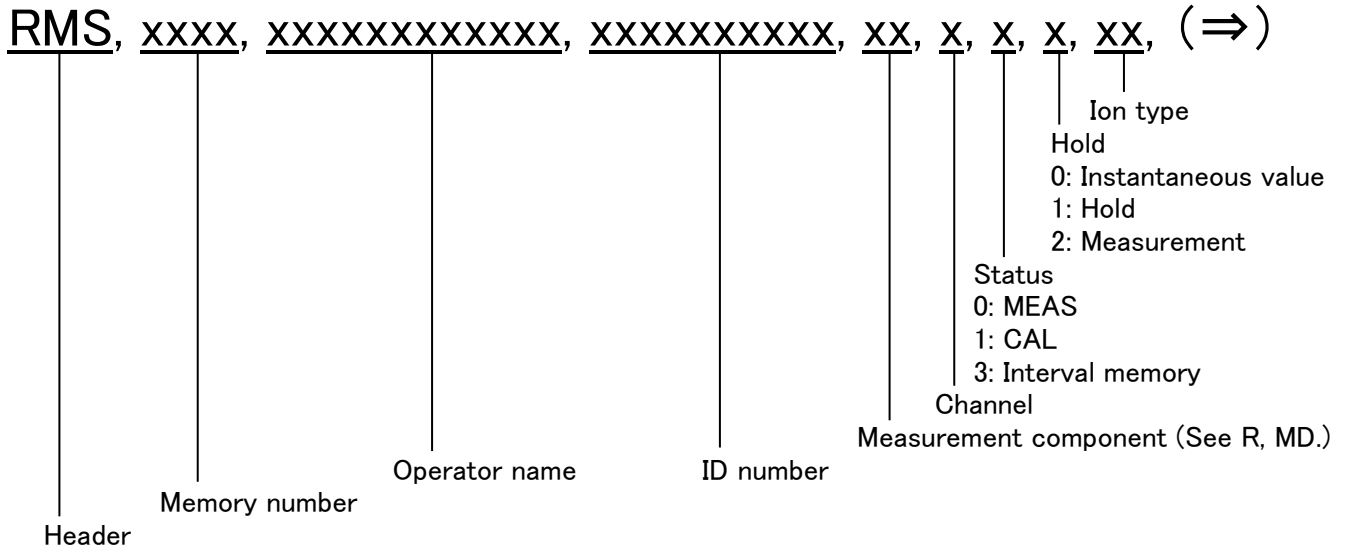

● Alarm inquiry command and response

Request command

R, AL, x, y, zzzzz... [CR][LF]

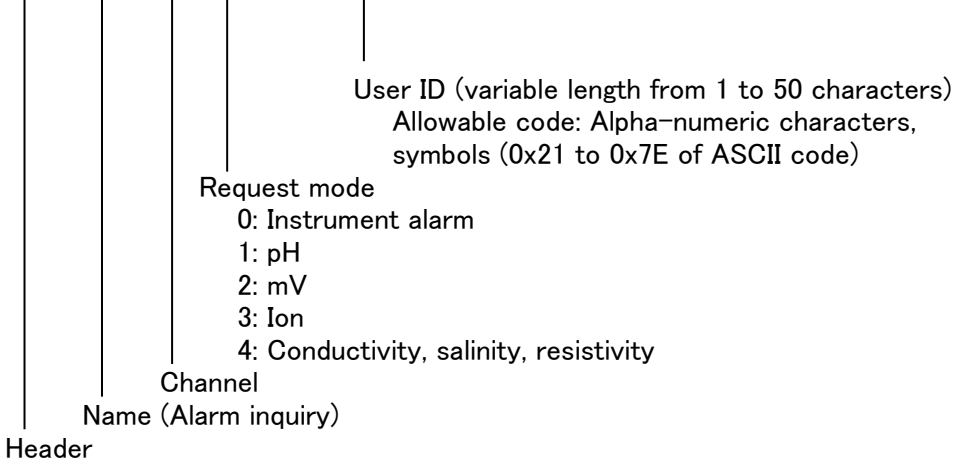

Requests the alarm code in the instrument.

Response from pH meter

RAL, x, y, zzzzzzzzz, zzzzz... [CR][LF]

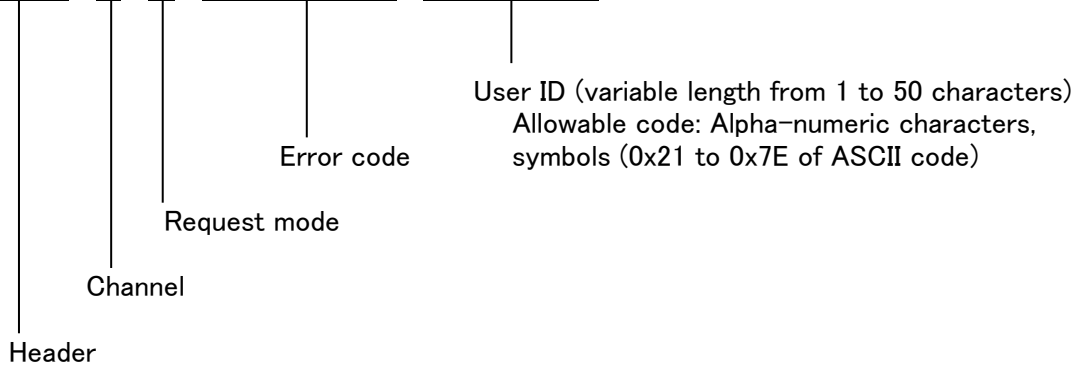

Error code

zzzzzzzz	Description
0x00000001	Internal memory error (instrument)
0x00000002	Lower battery error (instrument)
0x00000004	Electrode stability error (other than the instrument)
0x00000008	Asymmetry potential error (pH)
0x00000010	Sensitivity error (pH, ion)
0x00000020	Maximum calibration points exceeded (pH, ion)
0x00000040	Cannot identify standard solution (pH, conductivity)
0x00000080	Calibration interval error (pH)
0x00000100	Printer error (instrument)
0x00000200	Memory full (instrument)
0x00000400	Cell constant is out of range (conductivity)
0x00000800	USB memory write error (instrument)
0x00001000	USB memory capacity exceeded (instrument)
0x00002000	USB memory not inserted (instrument)
0x00004000	PC connection timeout (instrument)

If the plural number of errors are generated with the specified mode, the plural number of error bits are set.

● Clear of the currently displayed alarm information

Request command

R, AR, zzzzz... [CR][LF]

Header

Name (Request of alarm reset)

User ID (variable length from 1 to 50 characters)

Allowable code: Alpha-numeric characters, symbols (0x21 to 0x7E of ASCII code)

Clears the currently displayed alarm information.

• **Command function list (Setting)**

Item	Command		Function
	Header	Name	
Clock data setting	S (Set)	OT	Writes the clock data.

Response from pH meter

When it is OK:

Describes in each command.

or

ER, n, zzzzz... [CR][LF]

User ID (variable length from 1 to 50 characters)

Allowable code: Alpha-numeric characters, symbols (0x21 to 0x7E of ASCII code)

n = 1: A non-existent command was entered.

n = 2: The command was entered when the pH meter cannot accept it.

An unacceptable number was entered in the command.

● Write command of the clock data

S, OT, xxxx, xx, xx, xx, xx, xx, zzzzz... [CR][LF]

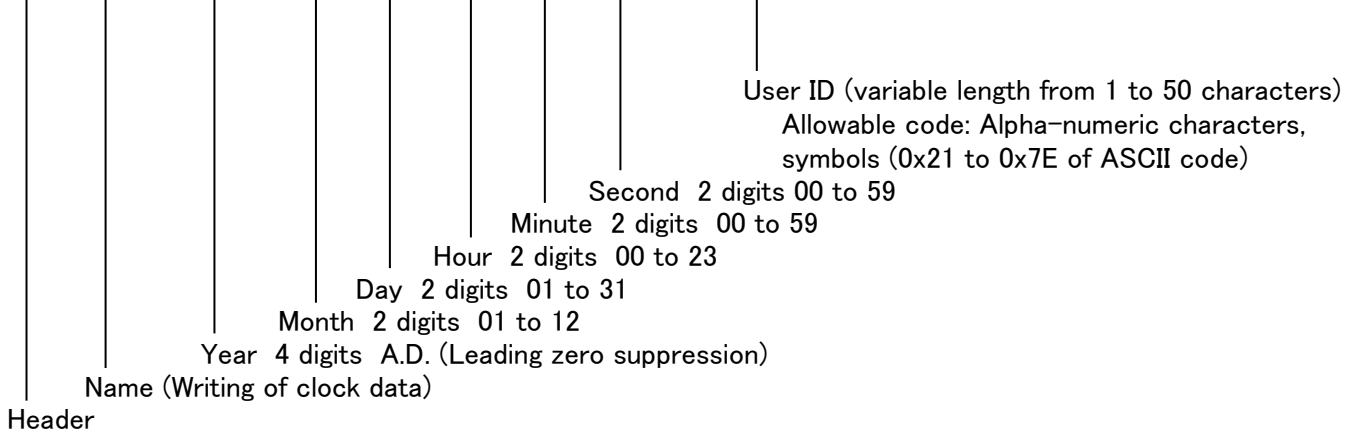

Writes the clock data.

An error response is returned when the a date and time that cannot be set are entered.