

Benchtop Conductivity Meter LAQUA-EC1100

Instruction Manual

CODE:GZ0000427794

Preface

This manual describes the operation of the Benchtop Conductivity Meter LAQUA-EC1100.

Be sure to read this manual before using the product to ensure proper and safe operation of the product. Also safely store the manual so it is readily available whenever necessary.

Product specifications and appearance, as well as the contents of this manual are subject to change without notice.

■ Warranty and responsibility

HORIBA, Ltd. warrants that the Product shall be free from defects in material and workmanship and agrees to repair or replace free of charge, at option of HORIBA, Ltd., any malfunctioned or damaged Product attributable to responsibility of HORIBA, Ltd. for a period of two (2) years from the delivery unless otherwise agreed with a written agreement. In any one of the following cases, none of the warranties set forth herein shall be extended;

- Any malfunction or damage attributable to improper operation
- Any malfunction attributable to repair or modification by any person not authorized by HORIBA, Ltd.
- Any malfunction or damage attributable to the use in an environment not specified in this manual
- Any malfunction or damage attributable to violation of the instructions in this manual or operations in the manner not specified in this manual
- Any malfunction or damage attributable to any cause or causes beyond the reasonable control of HORIBA, Ltd. such as natural disasters
- Any deterioration in appearance attributable to corrosion, rust, and so on
- Replacement of consumables

HORIBA, LTD. SHALL NOT BE LIABLE FOR ANY DAMAGES RESULTING FROM ANY MALFUNCTIONS OF THE PRODUCT, ANY ERASURE OF DATA, OR ANY OTHER USES OF THE PRODUCT.

■ Trademarks

- Microsoft, Windows, Windows Vista are registered trademarks or trademarks of Microsoft Corporation in the United States and other countries.

Other company names and brand names are either registered trademarks or trademarks of the respective companies. (R), (TM) symbols may be omitted in this manual.

Check items

■ Items in package

After opening the package, check for damage on the instrument and that the standard accessories (see below) all exist.

If damage or defects are found on the product, contact your dealer.

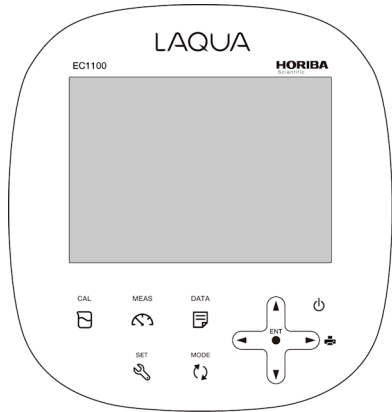

Instrument

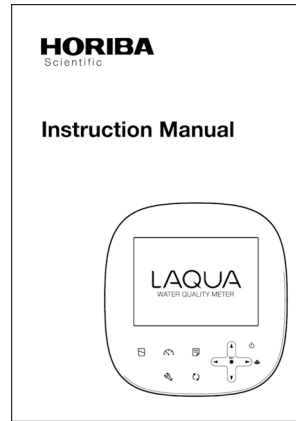

Instruction manual
(this book)

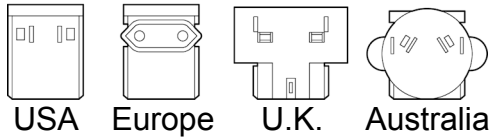
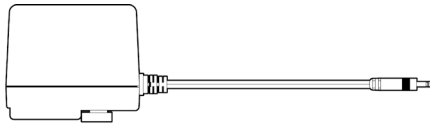

AC adapter

Regulations

■ EU regulations

● Conformable standards

This equipment conforms to the following standards:



EMC:	EN61326-1 Class B, Basic electromagnetic environment
Safety:	EN61010-1
RoHS:	EN50581 9. Monitoring and control instruments

Warning: This product is not intended for use in industrial environments. In an industrial environment, electromagnetic environmental effects may cause the incorrect performance of the product in which case the user may be required to take adequate measures.

● Installation environment

This product is designed for the following environment.

- Overvoltage Category II
- Pollution degree 2

● Information on disposal of electrical and electronic equipment and disposal of batteries and accumulators

The crossed out wheeled bin symbol with underbar shown on the product or accompanying documents indicates the product requires appropriate treatment, collection and recycle for waste electrical and electronic equipment (WEEE) under the Directive 2012/19/EU, and/or waste batteries and accumulators under the Directive 2006/66/EC in the European Union.

The symbol might be put with one of the chemical symbols below. In this case, it satisfies the requirements of the Directive 2006/66/EC for the object chemical.

This product should not be disposed of as unsorted household waste.

Your correct disposal of WEEE, waste batteries and accumulators will contribute to reducing wasteful consumption of natural resources, and protecting human health and the environment from potential negative effects caused by hazardous substance in products.

Contact your supplier for information on applicable disposal methods.

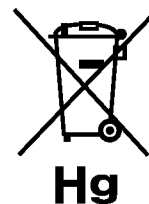
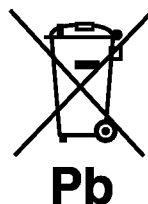
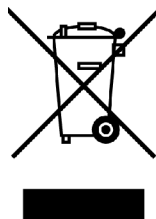

Regulations

■ FCC rules

Any changes or modifications not expressly approved by the party responsible for compliance shall void the user's authority to operate the equipment.

●WARNING

This equipment has been tested and found to comply with the limits for a Class A digital device, pursuant to part 15 of the FCC Rules. These limits are designed to provide reasonable protection against harmful interference when the equipment is operated in a commercial environment. This equipment generates, uses, and can radiate radio frequency energy and, if not installed and used in accordance with the instruction manual, may cause harmful interference to radio communications.

Operation of this equipment in a residential area is likely to cause harmful interference in which case the user will be required to correct the interference at his own expense.

■ Korea certification

●B급 기기 (가정용 방송통신기자재)

이 기기는 가정용(B 급) 전자파적합기기로서 주로 가정에서 사용하는 것을 목적으로 하며, 모든 지역에서 사용할 수 있습니다.

■ Taiwan battery recycling mark



廢電池請回收

For your safety

■ Hazard classification and warning symbols

Warning messages are described in the following manner. Read the messages and follow the instructions carefully.

● Hazard classification

 **DANGER**

This indicates an imminently hazardous situation which, if not avoided, will result in death or serious injury. This is to be limited to the most extreme situations.

 **WARNING**

This indicates a potentially hazardous situation which, if not avoided, could result in death or serious injury.

 **CAUTION**

This indicates a potentially hazardous situation which, if not avoided, may result in minor or moderate injury. It may also be used to alert against unsafe practices.

● Warning symbols



Description of what should be done, or what should be followed







Description of what should never be done, or what is prohibited



For your safety

■ Safety precautions

This section provides precautions for using the product safely and correctly and to prevent injury and damage. The terms of DANGER, WARNING, and CAUTION indicate the degree of imminency and hazardous situation. Read the precautions carefully as it contains important safety messages.

● Instrument and electrode

 WARNING	
	Do not use an unspecified AC adapter. Otherwise, it may heat up or be ignited resulting in a fire or an accident.
	Do not disassemble or modify the instrument. Otherwise, it may heat up or be ignited resulting in a fire or an accident.
	Fire <ul style="list-style-type: none">• For your safety, make sure to unplug the power plug from the electrical outlet when not in use.• Clear dust on the power plug periodically (a few times a year). If the power supply cord is left plugging into the electrical outlet for a long period of time, electrical tracking may occur due to dust and moisture, and it may result in an ignition or a fire.
	Fire or electric shock <ul style="list-style-type: none">• Do not bundle the power supply cord during use.• Do not damage the power supply cord nor apply an excessive load to it, such as bending and stretching it repeatedly, putting a heavy thing on it.• If it can not be plugged into an electrical outlet firmly, stop use of the power supply cord. If may result in overheating, a fire, an electrical shock, or breakdown.

 CAUTION	
	Broken glass Broken glass may cause injury. The outer tube and tip of an electrode are made of glass. Handle them with care.
	Do not use the RS-232C or USB communication and the AC adapter under wet or humid conditions. Otherwise, it may cause a fire, electric shock, or breakage.

■ Product handling information

● Operational precautions

- Only use the product including accessories for their intended purpose.
- Do not drop, crash, or give any physical impact on the instrument.
- Do not immerse the instrument into alcohol, organic solvent, strong acid, strong alkaline, or the like. The instrument body contains ABS resin, acrylic resin, and some rubber parts.
- If the instrument is dropped into water or gets wet, wipe it using soft cloth. Do not heat to dry it with a hair-dryer (or the like).
- Use fingers to press the operation keys or the touch panel. Do not use a hard object like a metal stick or rod.
- Be careful not to let water into the instruction inside. The instrument is not water-proof.
- To disconnect an electrode or interface cable, hold the connector and pull it off. If you pull at the cable, it may cause a breakage.
- The touch panel is capacitance-type. Make sure to turn OFF the power before cleaning the panel. If you wipe it with the power ON, it may cause instrument malfunction.
- RS-232C or USB communication between the instrument and a personal computer (referred to as PC in the rest of this document) may fail because of environmental conditions, such as (radio/electromagnetic) noise.
- Make sure to use the provided power supply cable to power this product.

● Environmental conditions for use and storage

- Temperature: 0°C to 45°C
- Humidity: under 80% in relative humidity and free from condensation

Avoid the following conditions.

- Strong vibration
- Direct sunlight
- Corrosive gas environment
- Close to an air-conditioner
- Direct wind
- Dusty environment

● Transportation

When transporting the instrument, repackage it in the original package box. Otherwise, it may cause instrument breakage.

For your safety

● Disposal

- Standard solution used for the calibration must be under neutralized before the disposal.
- When disposing of the product, follow the related laws and/or regulations of your country for disposal of the product.

Manual information

■ Description in this manual

Note

This interprets the necessary points for correct operation and notifies the important points for handling the product.

Reference

This indicates the part where to refer for information.

Tip

This indicates reference information.

Contents

Preface	I
■ Items in package	II
■ Hazard classification and warning symbols	V
■ Safety precautions.....	VI
■ Product handling information	VII
■ Description in this manual.....	IX
Part names and basic operation.....	1
■ Names of each part.....	2
● Instrument	2
● Display	4
● Operation key.....	5
■ Basic operation.....	6
● Function layer	6
● Changing the operation mode.....	8
● Changing the measurement parameter	9
● Entering numeric values	9
● Saving measurement data in the internal memory.....	10
Measurement.....	11
■ Preparation.....	12
● Confirmation before starting measurement.....	12
● Turning ON the instrument.....	13
● Connecting an electrode.....	14
■ Conductivity measurement.....	15
● Setting the instrument.....	16
● Performing conductivity calibration	26
● Performing measurement	29
● Saving measured values.....	30

Contents

● Printing measured values in the measurement mode.....	30
Using various functions	31
■ Data functions.....	32
● Displaying saved data	32
● Deleting all saved data	33
■ Measurement settings.....	34
● Displaying the latest calibration data.....	34
● Changing the calibration method	35
● Deleting calibration data	36
■ Temperature setting	38
● Calibrating temperature sensor.....	38
■ General settings	39
● Setting the auto stability and the auto hold function	39
● Resetting to factory default settings.....	41
● Performing test printing of the printer unit	42
● Setting automatic print.....	43
● Setting password	44
■ Other settings	46
● Printing measured values and calibration data	46
● Transferring saved data to a PC.....	49
● Operating the instrument from an external device	50
Maintenance	51
● Contact for maintenance	51
● Maintenance and storage of the instrument.....	51
● Environmental conditions for storage	51
● Maintenance and storage of the conductivity cell.....	52
How to resolve errors or troubles	53

Contents

■ When an error message appears	53
● ERROR No.0001 Memory error	53
● ERROR No.0006 Maximum calibration points exceeded ...	53
● ERROR No.0009 Printer error	54
● ERROR No.0010 Memory full	54
● ERROR No.0011 Cell constant is out of range	54
■ Troubleshooting	55
● The indicated value fluctuates	55
● The response is slow	55
● The indicated value does not change/No response	56
● The measured value is outside the display range	56
● Repeatability of the measured value is poor	56
● Nothing appears when the power is turned ON.....	57
● Part of the display is missing	57
Appendix.....	59
■ Main specifications.....	59
● Table of conductivity cell range	61
● Table of conductivity cell range (resistivity range)	62
■ Functions.....	62
■ Instrument default settings.....	63
■ Technical note.....	64
● Conductivity standard values at various temperatures	64
■ Options	65

Part names and basic operation

This section describes the name of each part and the main role, function, and basic operation method of each part.

■ Names of each part.....	2
● Instrument.....	2
● Display.....	4
● Operation key	5
■ Basic operation.....	6
● Function layer.....	6
● Changing the operation mode	8
● Changing the measurement parameter.....	9
● Entering numeric values.....	9
● Saving measurement data in the internal memory	10

■ Names of each part

● Instrument

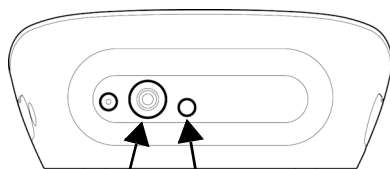
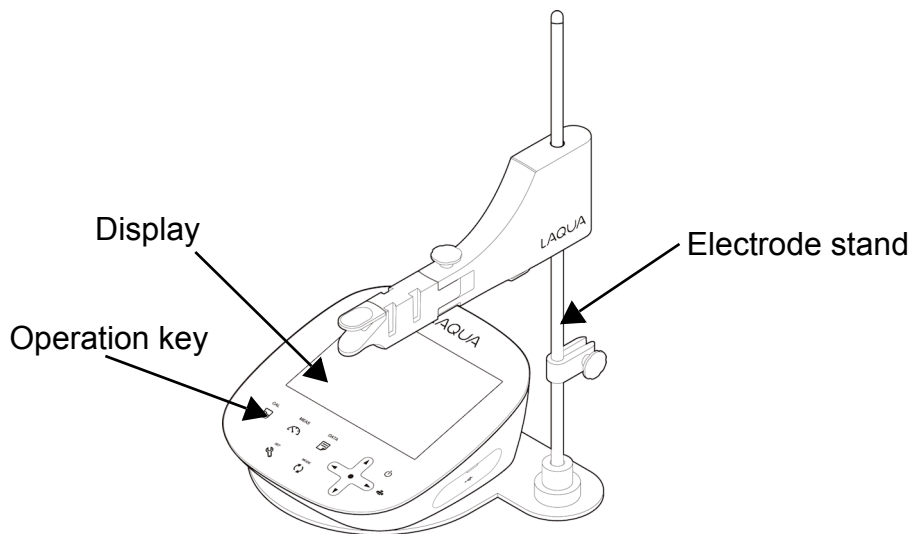

CH2 measurement electrode (G) connector

CH2 temperature electrode (T) jack

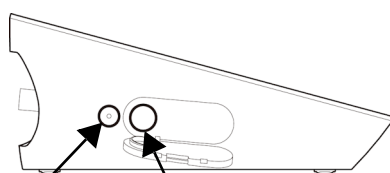

AC adapter jack

Printer or RS-232C connector

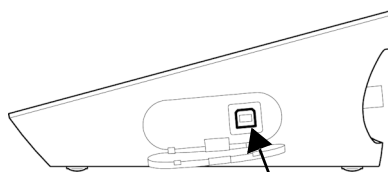

Connector for USB communication with a PC

• Identification of manufacturing date

Manufacturing date can be identified from MFG No. described in the ID label on the backside of the instrument.

Third number from the left in the MFG No. indicates manufacturing year.

Fourth alphabet from the left in the MFG No. indicates manufacturing month.

The alphabet is assigned to month according to the table below.

Ex.: ID: AA6A0000 means the device manufactured in 2016 January.





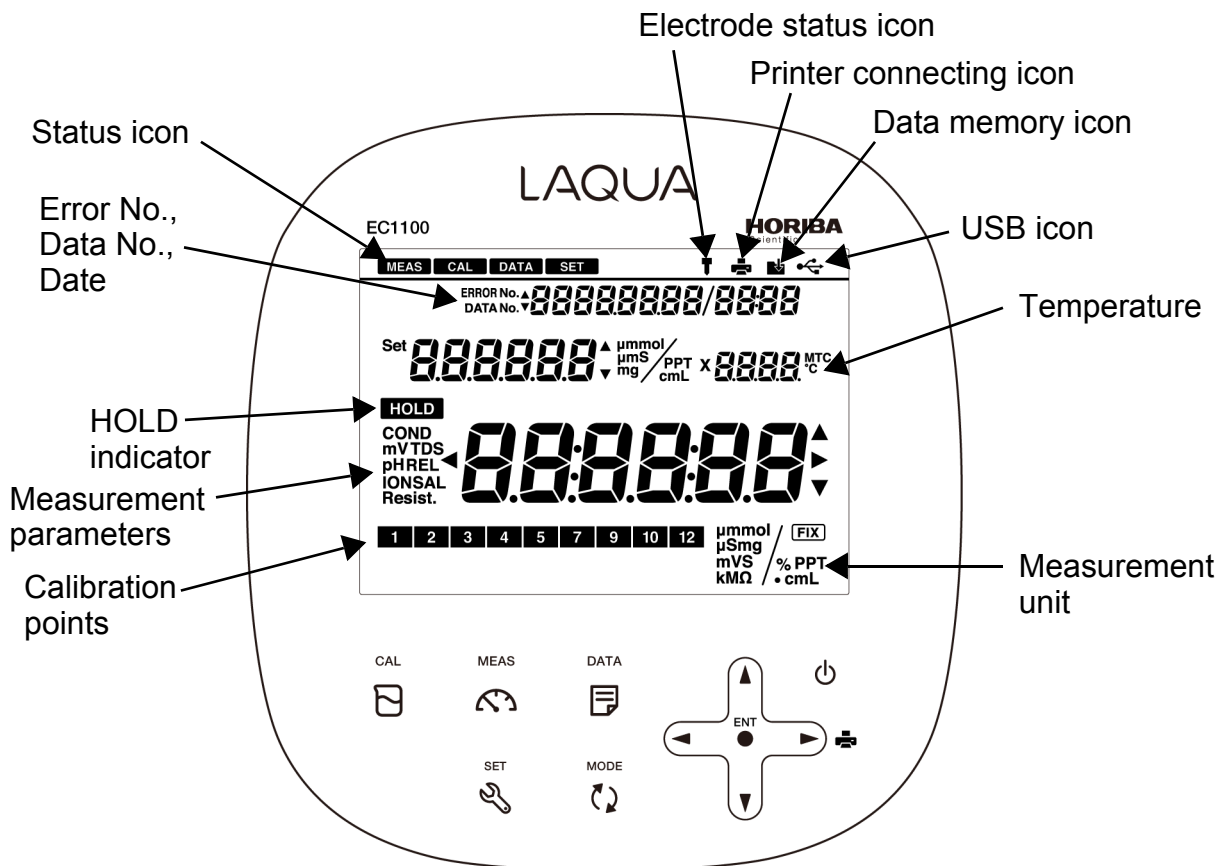



JAN	FEB	MAR	APR	MAY	JUN	JUL	AUG	SEP	OCT	NOV	DEC
A	B	C	D	E	F	G	H	J	K	L	M

● Display

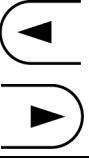

● Operation key

This instrument employs capacitance switches. You can not operate them with thick gloves. Operate them with bare hands or thin rubber gloves.

Key	Name	Function
CAL 	CAL key	Enters the calibration mode. Performs the calibration.
MEAS 	MEAS key	Enters the measurement mode. Releases the fixed measurement value in auto hold mode.
DATA 	DATA key	Enters the data mode.
SET 	SET key	Enters the setting mode. Cancels the setting values of the setting mode.
MODE 	MODE key	Switches the measurement items.
	▲ key ▼ key	Increases the values. Decreases the values. Switches the setting item. Switches the channels.
	◀▶ key	Changes number of digits, selects functions. Prints out the measurement values. (▶ key)
ENT 	ENTER key	Settlement, execution Saves the measurement data in the measurement mode. Starts/stops automatic data memory.
	POWER key	Turns ON or OFF the power. Press the POWER key for one second or longer to turn ON or OFF the power.

Tip

"ERROR No." icon is displayed on the screen when pressing the invalid key.

■ Basic operation



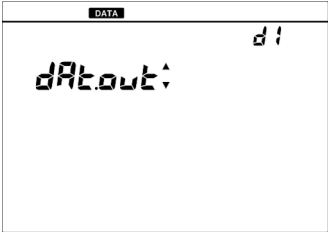
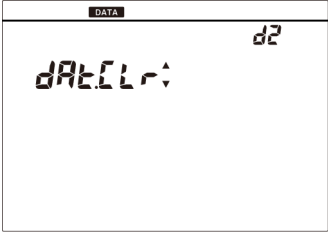

● Function layer

The function layer of the data mode and setting mode is shown as below.
 "dX" and "PXX" indicates the program number which is shown in the screen of the instrument.

- Data mode

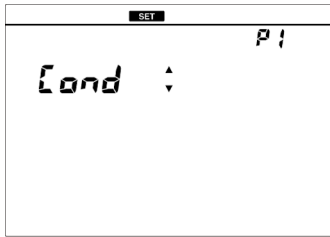
Screen	Layer	Description
	d1: DAT.OUT	Saved data display
	d2: DAT.CLR	Deletion of saved data

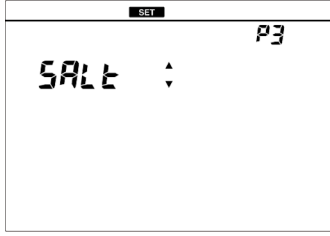
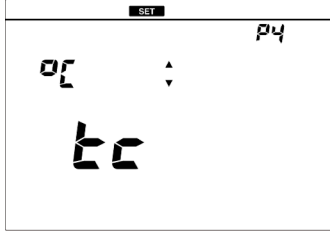
• Setting mode

Screen	Layer	Description
	P1: COND	Conductivity measurement settings
	P11: CELL	Cell constant setting
	P12: UNIT	Selection of unit: S/cm, S/m, mS/cm FIX
	P13: CAL.DAT	Calibration data display
	P14: AT. CAL	Selection of auto calibration, manual calibration
	P15: CAL.CLR	Deletion of calibration data
	P16: TC	Temperature conversion setting: 0.00%/°C to 10.00%/°C
	P17: TC REF	Reference temperature setting: 15°C to 30°C
	P2: TDS	TDS measurement settings
	P21: TYPE	Selection of TDS calculation method: Linear, 442, En, NaCl
	P3: SALT	Salinity measurement settings
	P31: UNIT	Selection of unit: %, ppt
	P32: TYPE	Selection of salinity calculation method: NaCl, SEAWATER
	P4: TC	Temperature settings Selection of temperature conversion: ATC, MTC
	P5: GEN	General settings
	P51: MEAS	Selection of auto hold type: auto stability, auto hold
	P52: RESET	Initialization of settings
	P53: PRINT	Test print
	P54: AT. PRN	Automatic print setting
	P55: PASS	Password

● Changing the operation mode

Change the operation mode from four available modes depending on the purpose of use. The status icon indicates the current mode.

You can change the operation mode using the corresponding key. However changing to the calibration mode, data mode, or setting mode is possible only from the measurement mode. When changing to a different mode, first change to the measurement mode and then change to the desired mode



Icon	Name	Function
MEAS	Measurement mode	Performs measurement.
CAL	Calibration mode	Performs calibration.
DATA	Data mode	Performs data settings. Displays the saved data.
SET	Setting mode	Performs various settings. Displays the calibration and inspection history.

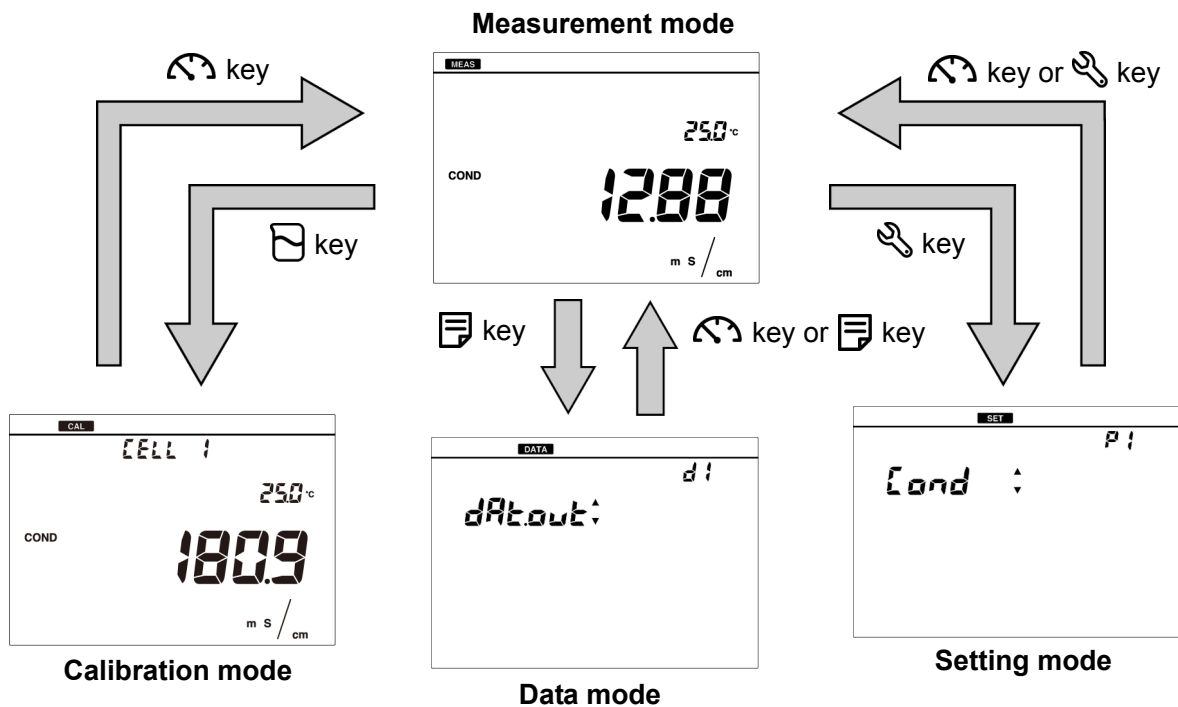



● Changing the measurement parameter

This instrument measures multiple parameters.

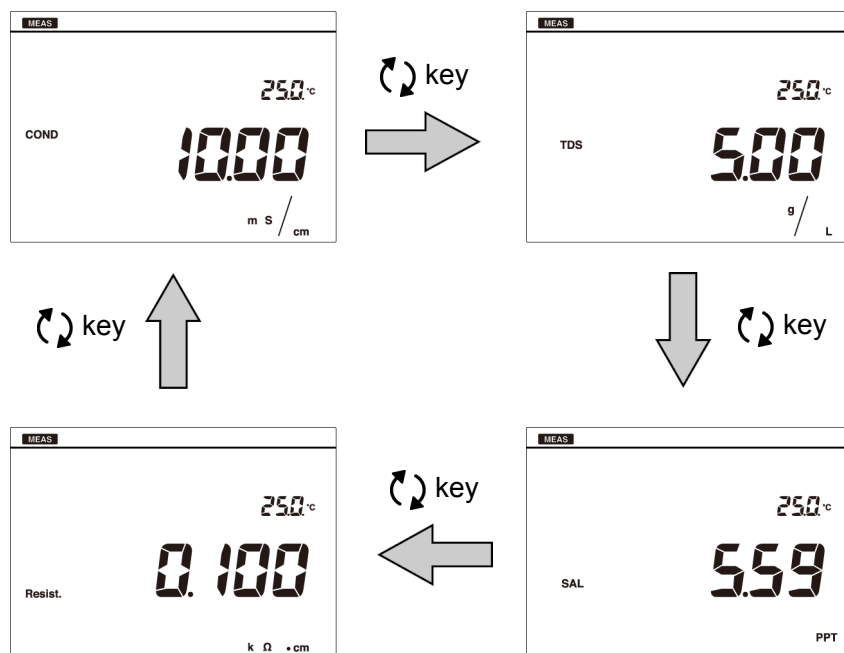
In the measurement mode, the measurement parameter can be changed by pressing the  key.



● Entering numeric values

When entering numeric values to make various settings and set a calibration value, change the selected digit using the  keys and increment or decrement the value (0 to 9) using the  keys.

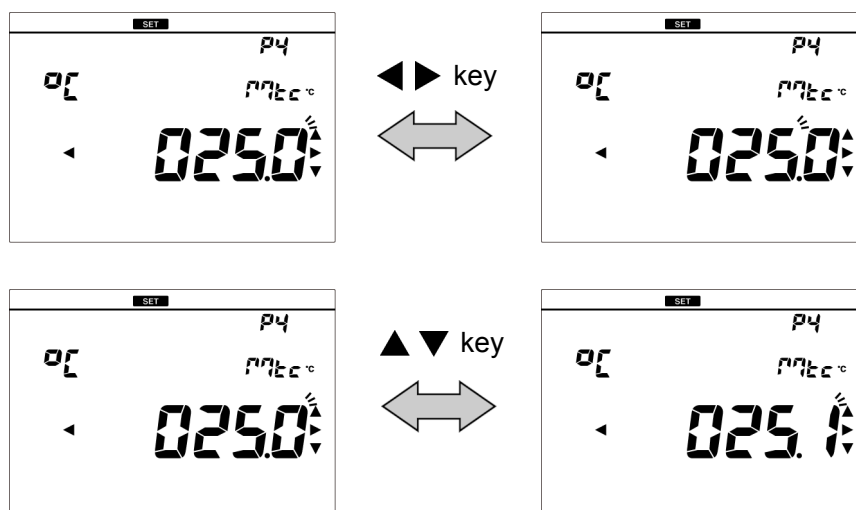

● Saving measurement data in the internal memory

Up to 500 data items measured by the instrument can be stored in the internal memory. Saving the measurement data is possible only when the instrument is in the measurement mode.

1. Press the ● key while the data to save is displayed.

The saved data is displayed for two seconds, and then the display automatically return to the previous screen.

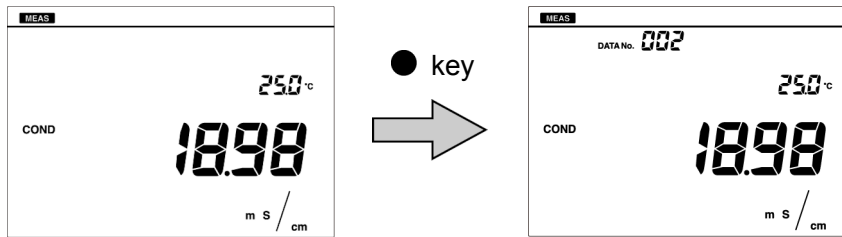

Note

If the data saved reaches 500, an error occurs and "ERROR No. 0010" is displayed. Copy or transfer necessary data to a PC and delete the data from the memory (refer to "Deleting all saved data" (page 33)).

Measurement

This section describes the basic method of measurement of each measurement parameters.

■ Preparation	12
● Confirmation before starting measurement	12
● Turning ON the instrument.....	13
● Connecting an electrode	14
■ Conductivity measurement.....	15
● Setting the instrument	16
● Performing conductivity calibration.....	26
● Performing measurement	29
● Saving measured values	30
● Printing measured values in the measurement mode	30

■ Preparation

● Confirmation before starting measurement

- Have you prepared the appropriate electrode for the measurement parameter?
⇒ If not, purchase the appropriate electrode.
- Is the prepared electrode in good condition?
⇒ If the responsive part is stained or damaged, it may not be possible to obtain accurate values.
- Have you prepared the appropriate standard solution for the measurement parameter?
⇒ If not, prepare the standard solution according to your applications.
- Are there any items that should not be wet or stained around the instrument?
⇒ Depending on the operation during measurement, items around the instrument could get wet or stained. Secure sufficient space around the instrument and perform measurement while always paying attention to safety.
- Are there any devices that can be a source of noise?
⇒ Measured values could be affected. Do not use the instrument near such devices.
Always ground devices operated by AC power.

● Turning ON the instrument

Perform the following procedure to connect AC adapter to the instrument.

1. Insert the AC adapter cable by fitting with the AC adapter jack.

2. Insert the AC adapter into the electrical socket.

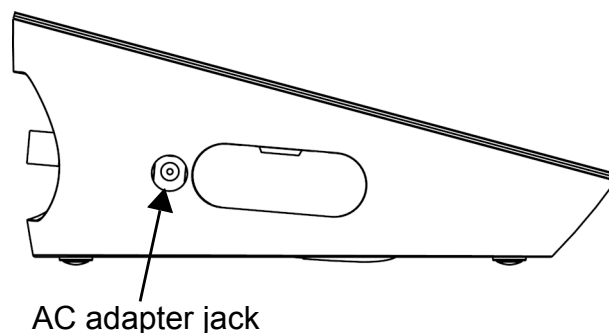

3. Press the  key.

The LCD is fully displayed for one second, and the screen displays the version number of software and the model, and then displays the measurement mode.

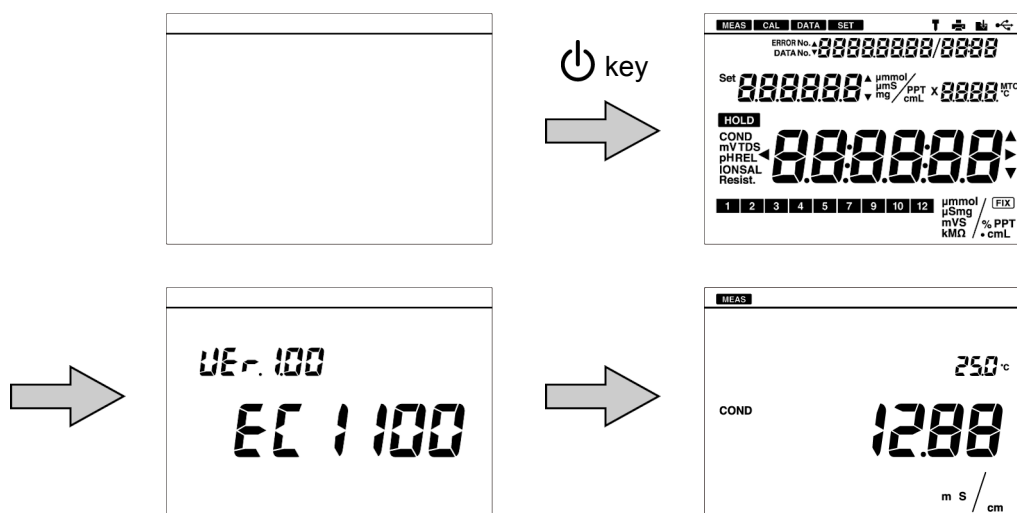

Note

- Do not insert the cable with force when the connector does not match the socket.
- Release your finger from the  key after the power of the instrument is turned ON.
- "VER" indicates the version of software. It may be revised when the software is updated.

● Connecting an electrode

To perform measurement, it is necessary to use the appropriate electrode for measurement parameters. Recommended electrodes for each measured sample are listed in our product catalog and on our website. Refer to them when preparing electrodes. Use the following procedure to correctly connect the electrode to the instrument.

1. Insert the electrode connector by fitting its groove with the connector socket pin of the CH2 measurement electrode (G).

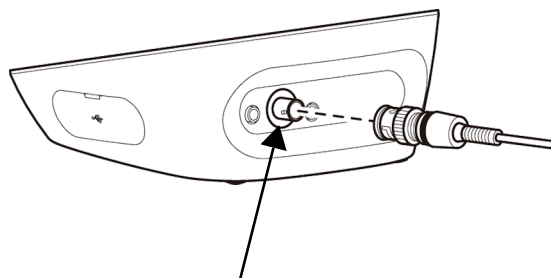

CH2 measurement electrode (G)

2. Turn the electrode connector clockwise by following the groove.

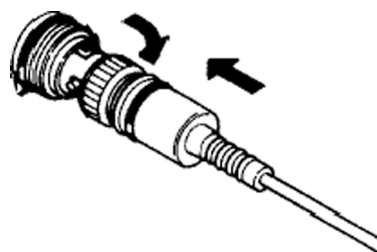

3. Put the connector cover on the connector.

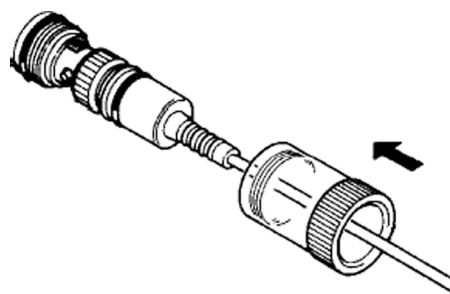

4. When using a combination electrode equipped with a temperature sensor, insert the temperature connector into the jack of the CH2 temperature electrode (T).

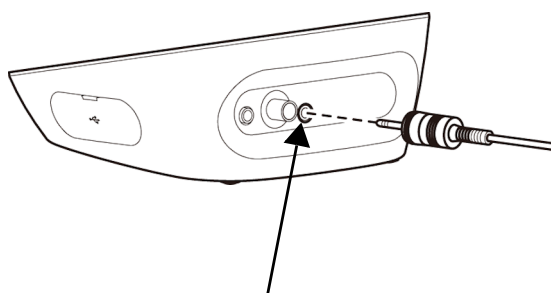

CH2 temperature electrode (T)

Tip

If the temperature connector is unconnected or the connection is wrong, temperature selected for MTC (manual temperature compensation) is displayed as the sample temperature.

Preparation for measurement is complete.
For details of the measurement operation, refer to the following pages.





■ Conductivity measurement

The conductivity cell can be used to measure the conductivity, salinity, TDS, and resistivity of a sample. Salinity, TDS, and resistivity are calculated from the measured conductivity value.

Press the  key to select the measurement parameter (refer to “ Changing the measurement parameter ” (page 9)).

The basic steps are the same for all measurement parameters, however, some settings and operations are only valid for specific measurement parameters. Select the settings and perform the steps that show the mark of the parameter you want to measure.

< Examples >

-  : Conductivity measurement
-  : Salinity measurement
-  : Total dissolved solids measurement
-  : Resistivity measurement
-  : All measurement parameters

● Setting the instrument

• Setting the temperature display ALL

When a conductivity cell with a temperature sensor is used, or a conductivity cell without a temperature sensor is used with a temperature electrode, the automatic temperature measurement function can be used. During measurement, the temperature sensor measures the temperature of the sample and displays the result on the instrument. If automatic temperature measurement function is not used, or the temperature connector is not connected to the instrument, the temperature set in the instrument is displayed.

1. Press the  key to enter the setting mode.

2. Press the   keys to select "TC" (temperature setting) and then press the  key.

If the temperature connector is connected, "ATC" (automatic temperature compensation) appears. If not connected, "MTC" (manual temperature compensation) appears.

In the case of "ATC," you can calibrate temperature sensor (refer to "Calibrating temperature sensor" (page 38)).

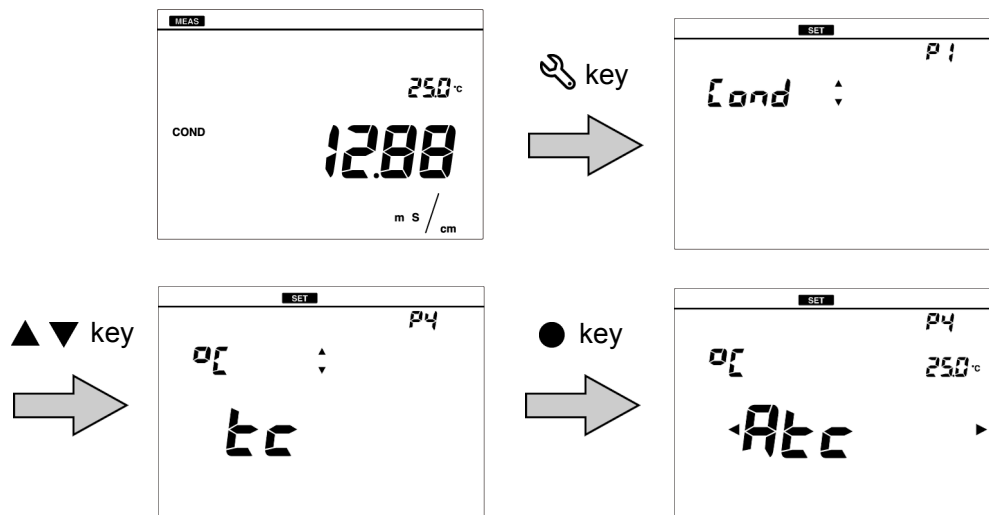

3. In the case of "MTC", enter the temperature to be compensated for and press the  key to confirm.

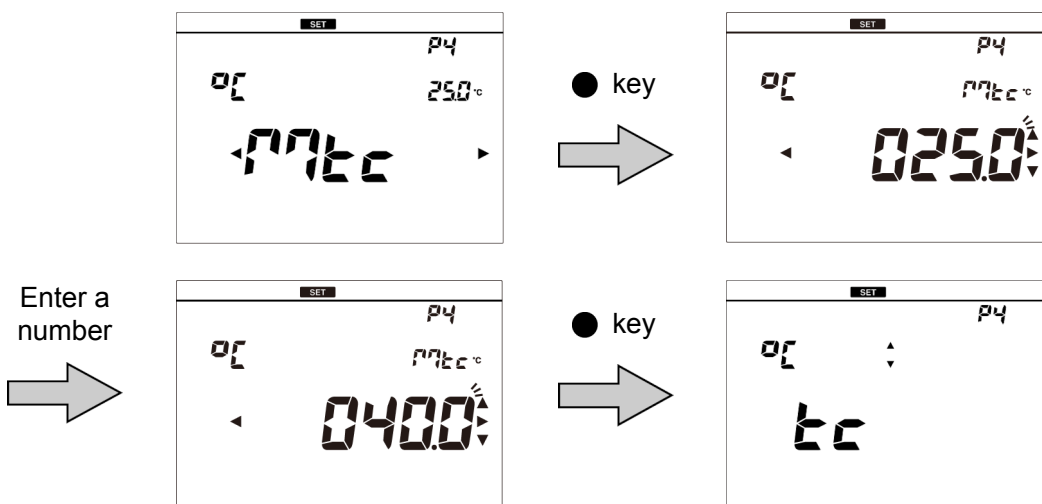







To return to the measurement mode, press the  key.

• **Setting the conductivity unit (default: S/cm) COND RESIST**

Select the conductivity unit from three options, S/cm, S/m, mS/cm FIX (fixed at mS/cm) depending on your application.

When measuring resistivity, these units correspond to $\Omega \cdot \text{cm}$, $\Omega \cdot \text{m}$, $\Omega \cdot \text{cm}$ (for mS/cm FIX).

1. Press the  key to enter the setting mode.
2. Press the   keys to select "COND" (conductivity setting) and then press the  key.
3. Press the   keys to select "UNIT" (unit setting) and then press the  key.

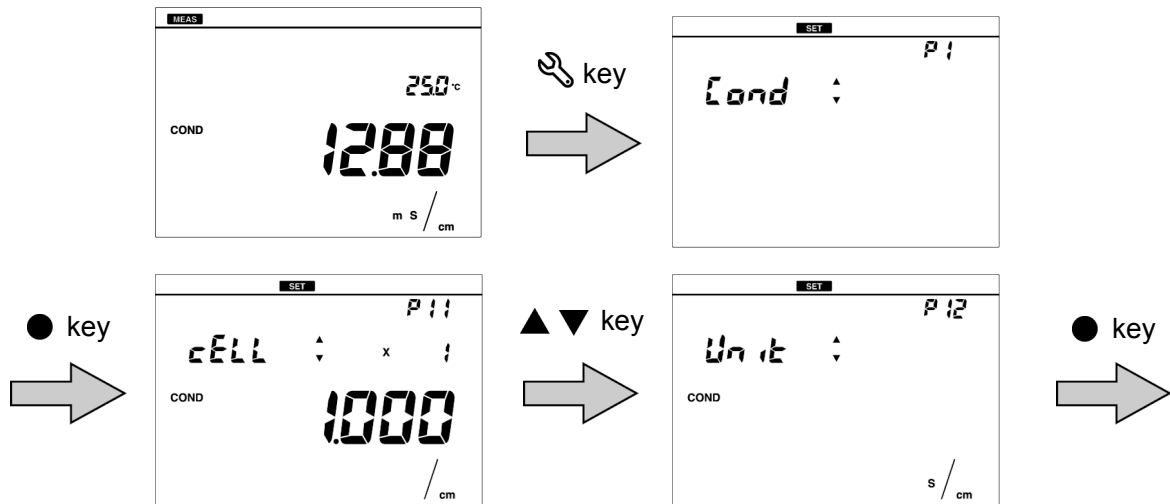



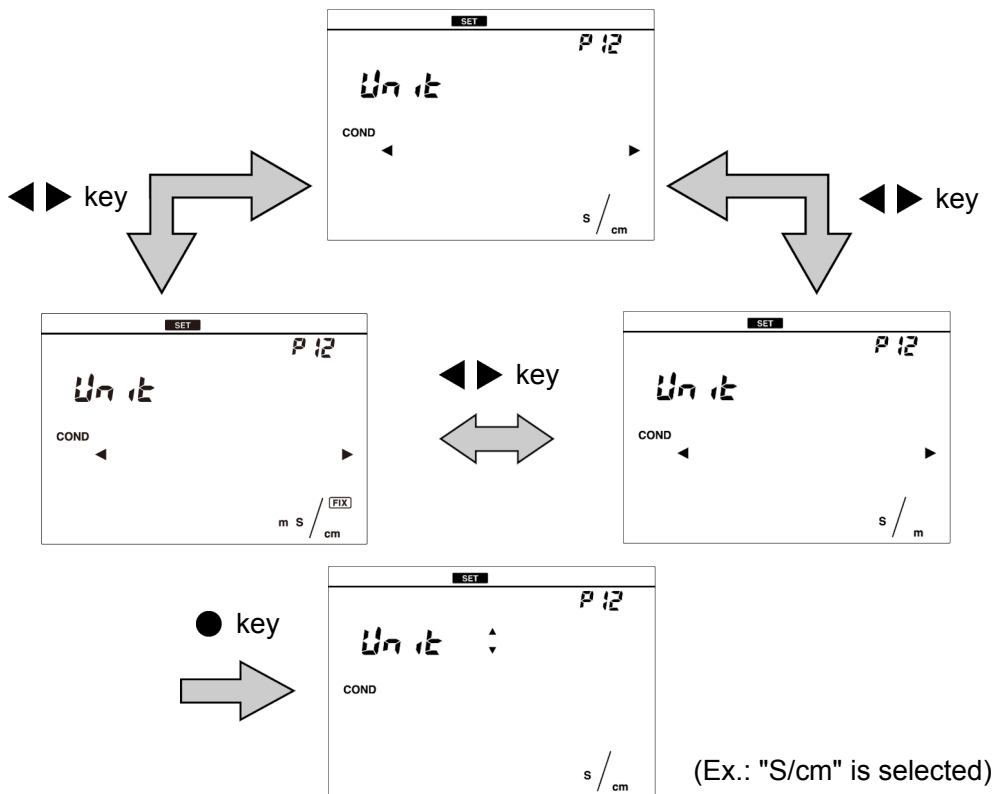

4. Press the   keys to select the unit and press the  key to confirm.



To return to the measurement mode, press the  key.

• **Setting the salinity unit (default: PPT) (SAL)**

Select the salinity unit from % or PPT depending on your application.

1. Press the  key to enter the setting mode.
2. Press the  key to select "SALT" (salinity setting) and then press the  key.
3. Press the  key to select "UNIT" (unit setting) and then press the  key.

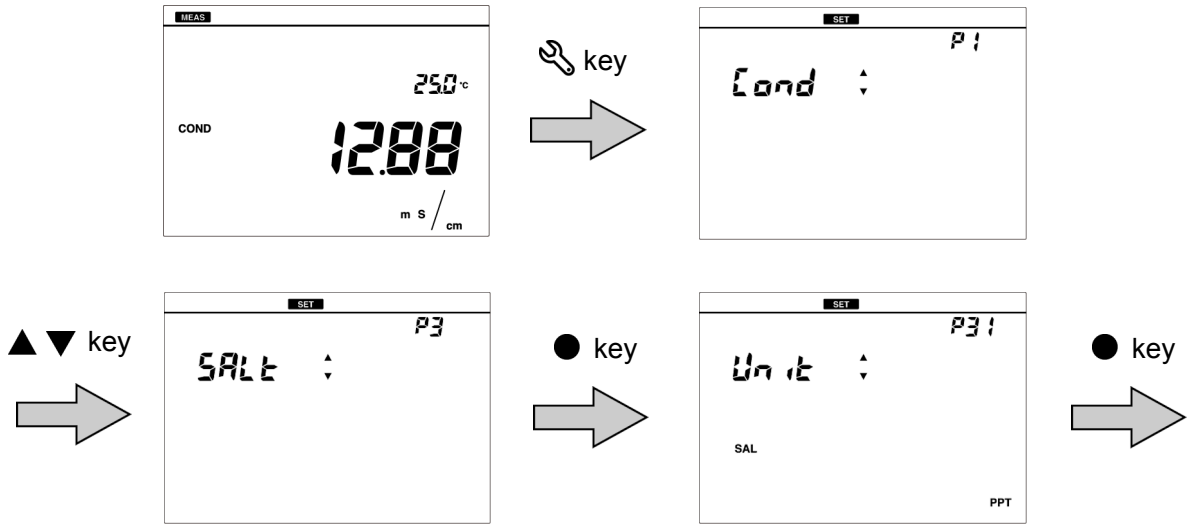



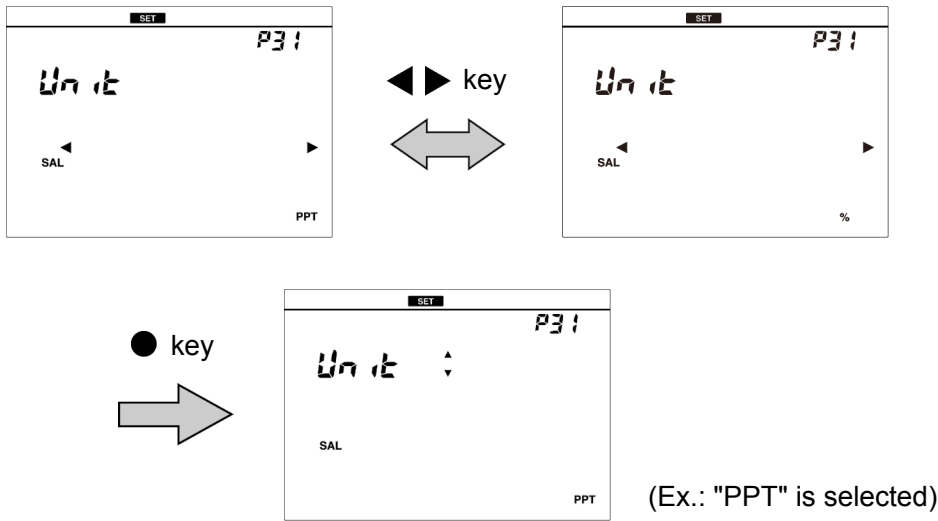



4. Press the  key to select the unit and press the  key to confirm.







To return to the measurement mode, press the  key.

• **Setting the cell constant (default: $1.000 \times 1.0 \text{ cm}^{-1}$)** (ALL)

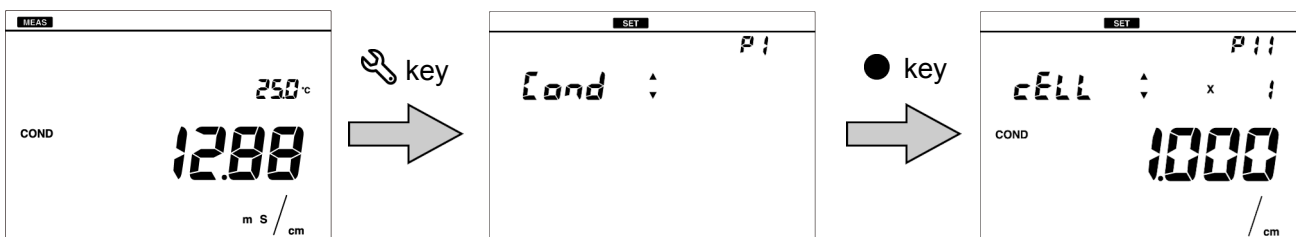
A cell constant is unique for each conductivity cell. To measure conductivity correctly, the cell constant of the conductivity cell must be set in the instrument.

1. Press the  key to enter the setting mode.
2. Press the   keys to select "COND" (conductivity setting) and then press the  key.
3. Press the   keys to select "CELL" (cell constant setting) and then press the  key.



4. Press the   keys to select the digit number of the cell constant of the conductivity cell and then press the  key.

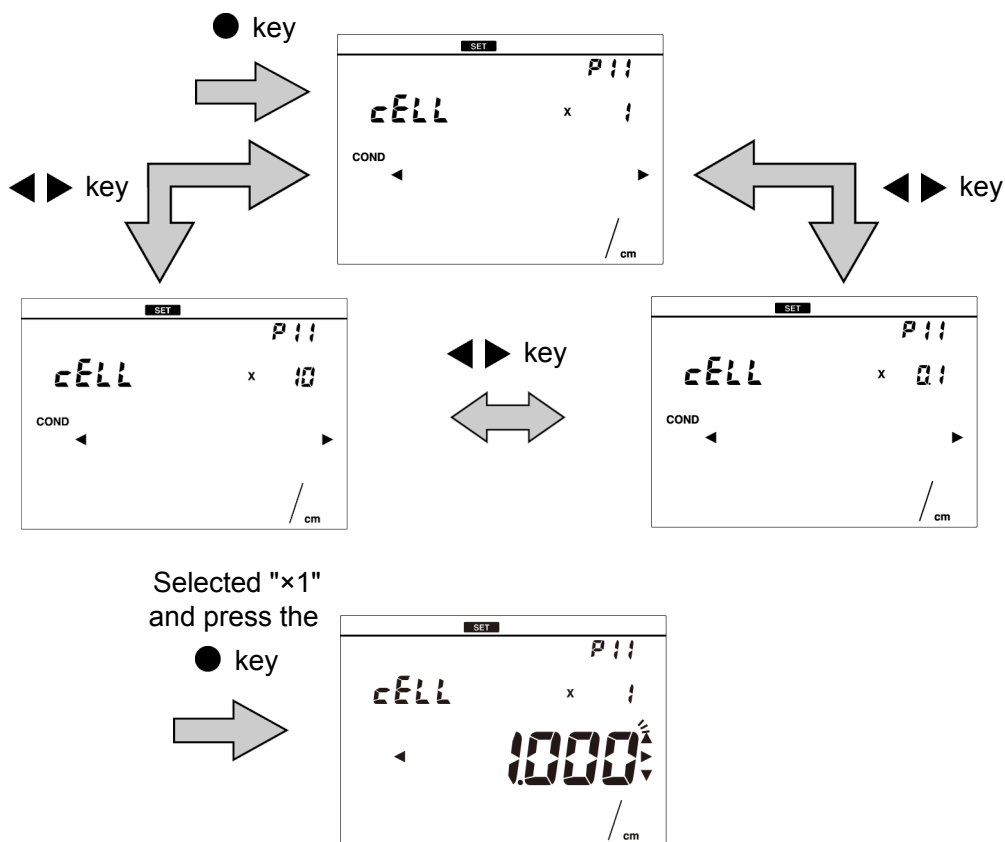

5. Press the ▲▼◀▶ keys to enter the cell constant value of the conductivity cell and then press the ● key to confirm.

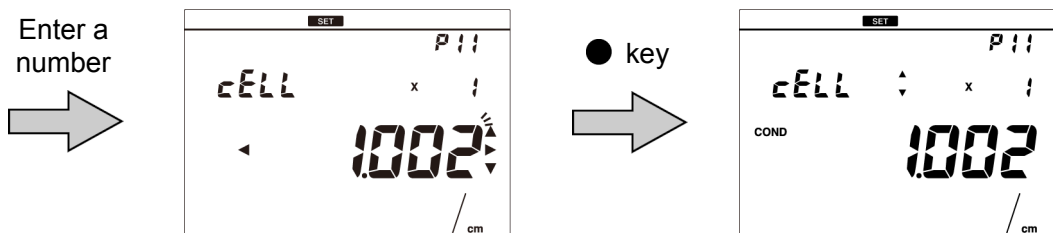

To return to the measurement mode, press the ↶ key.







Note

- The unit used for the cell constant corresponds the unit set in “ Setting the conductivity unit (default: S/cm) ” (page 17).
- When the cell constant is changed through the cell constant setting, all the previous calibration data is deleted.
- Match the unit indicated on the conductivity cell to the unit set in the instrument.

$$10 \text{ m}^{-1} \Leftrightarrow 0.1 \text{ cm}^{-1} \quad 100 \text{ m}^{-1} \Leftrightarrow 1 \text{ cm}^{-1} \quad 1000 \text{ m}^{-1} \Leftrightarrow 10 \text{ cm}^{-1}$$

• **Setting the temperature conversion (Default: ON, 2.00%/°C)** (ALL)

The measured value of a sample that is not at 25°C can be converted to a value at the selected temperature. To use the temperature conversion function correctly, temperature coefficient (the rate of change per 1°C of the conductivity) must be set for each sample. The setting of "Setting the temperature display" (page 16) is applied to the sample temperature before the conversion.

1. Press the  key to enter the setting mode.
2. Press the   keys to select "COND" (conductivity setting) and then press the  key.
3. Press the   keys to select "TC" (temperature conversion setting) and then press the  key.

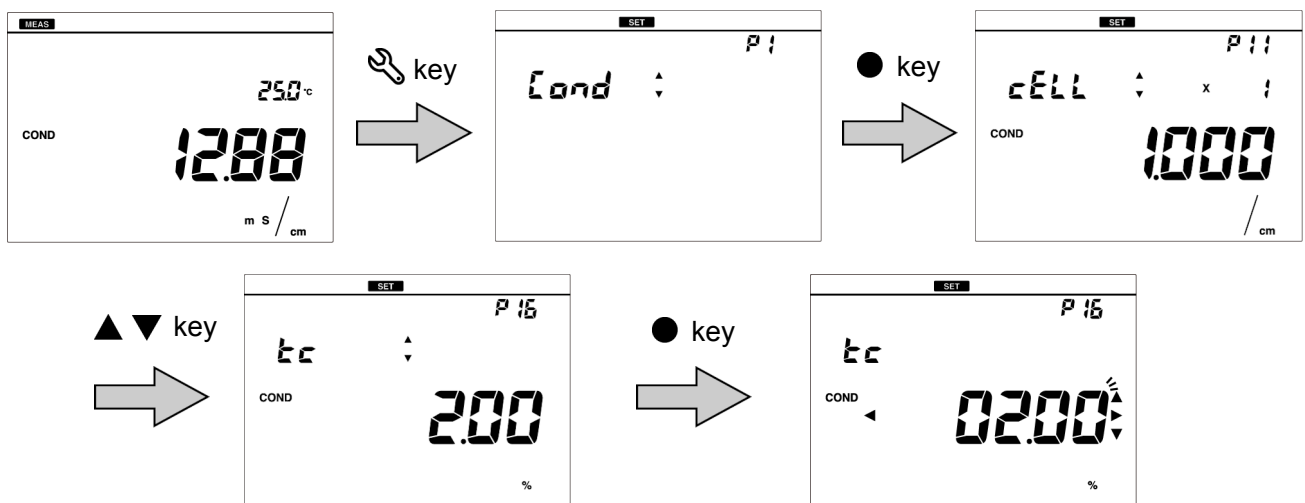

4. Press the     keys to enter the temperature coefficient and then press the  key to confirm.

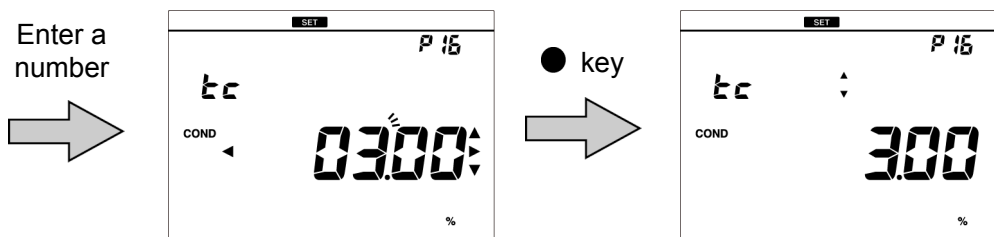







To return to the measurement mode, press the  key.

Note

- The temperature coefficient varies by sample. Before using the temperature conversion function, always check the temperature coefficient of the sample and set it in the instrument.
- When the temperature conversion function is used with automatic temperature measurement (ATC), deviations may occur within the accuracy of the temperature sensor. For more accurate measurement, set the temperature setting to manual temperature display (MTC), and measure using a temperature controlled bath.

• **Setting the reference temperature (Default: 25°C) (COND)**

Temperature to be converted can be selected from 15°C to 30°C.

1. Press the  key to enter the setting mode.
2. Press the   keys to select "COND" (conductivity setting) and then press the  key.
3. Press the   keys to select "TC REF" (reference temperature setting) and then press the  key.

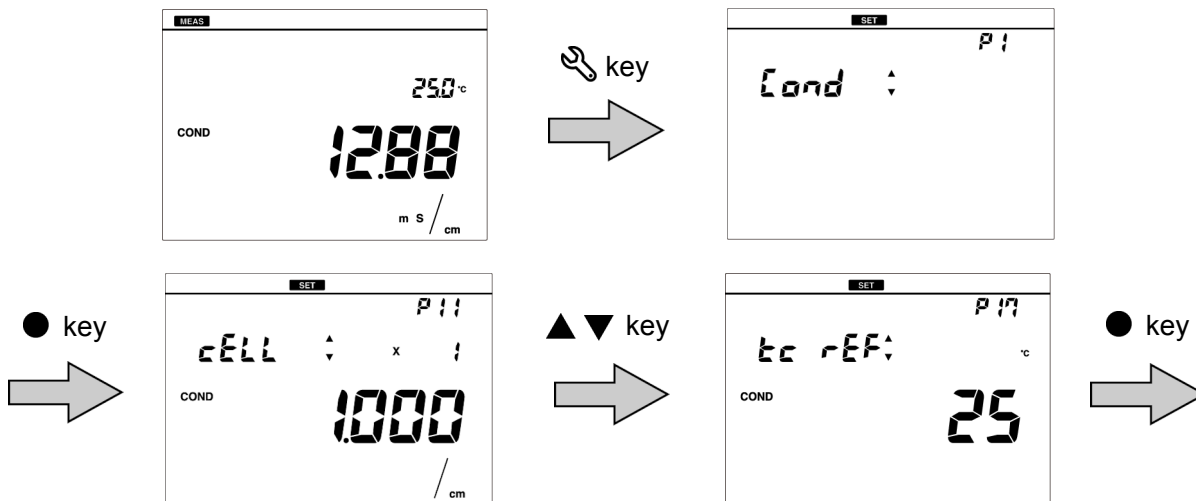

4. Press the     keys to enter the reference temperature and then press the  key to confirm.



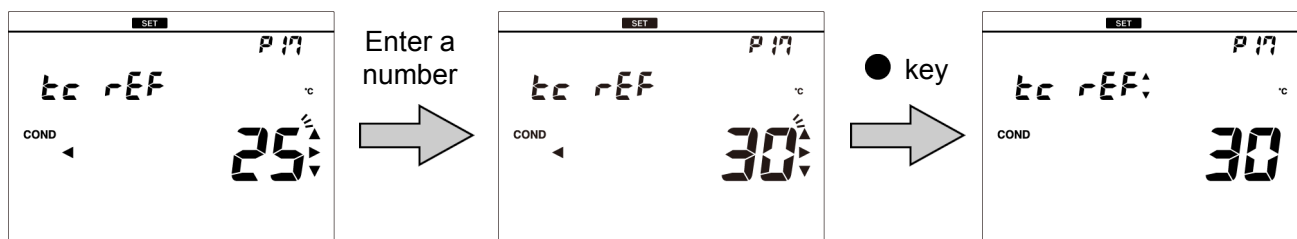

Temperature can be selected from 15°C to 30°C.



To return to the measurement mode, press the  key.

• **Setting the TDS method** TDS

TDS is calculated from the measured conductivity value. The available calibration methods are "Linear": KCl with factor adjustable from 0.40 to 1.00 (default: 0.50), "442": Myron L 442 non-linear standard curve, "En": European environmental standard non-linear curve, and "NaCl": non-linear salinity curve.

1. Press the  key to enter the setting mode.
2. Press the  keys to select "TDS" (total dissolved solids setting) and then press the  key.
3. Press the  keys to select "TYPE" (TDS method setting) and then press the  key.

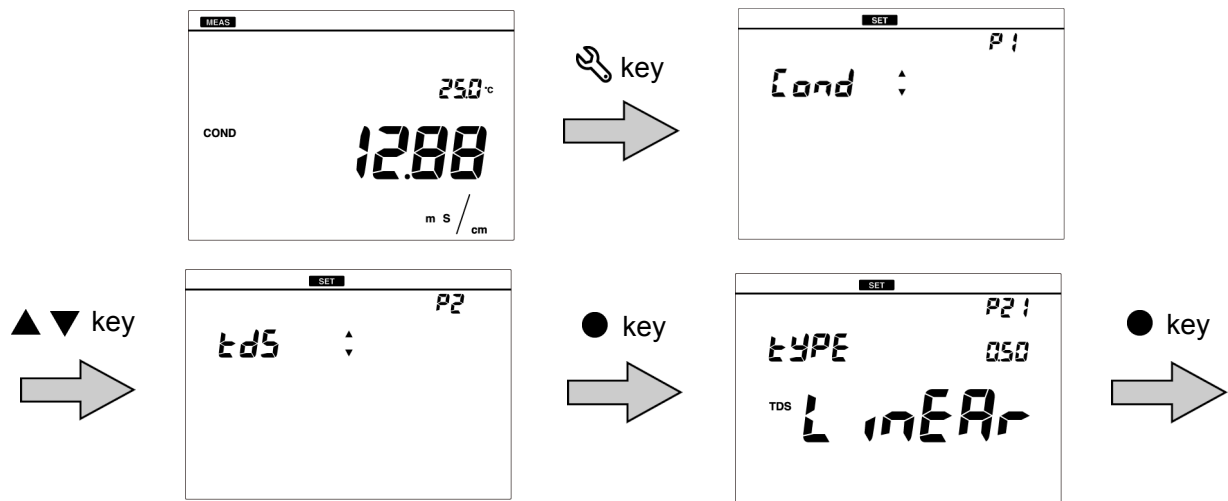



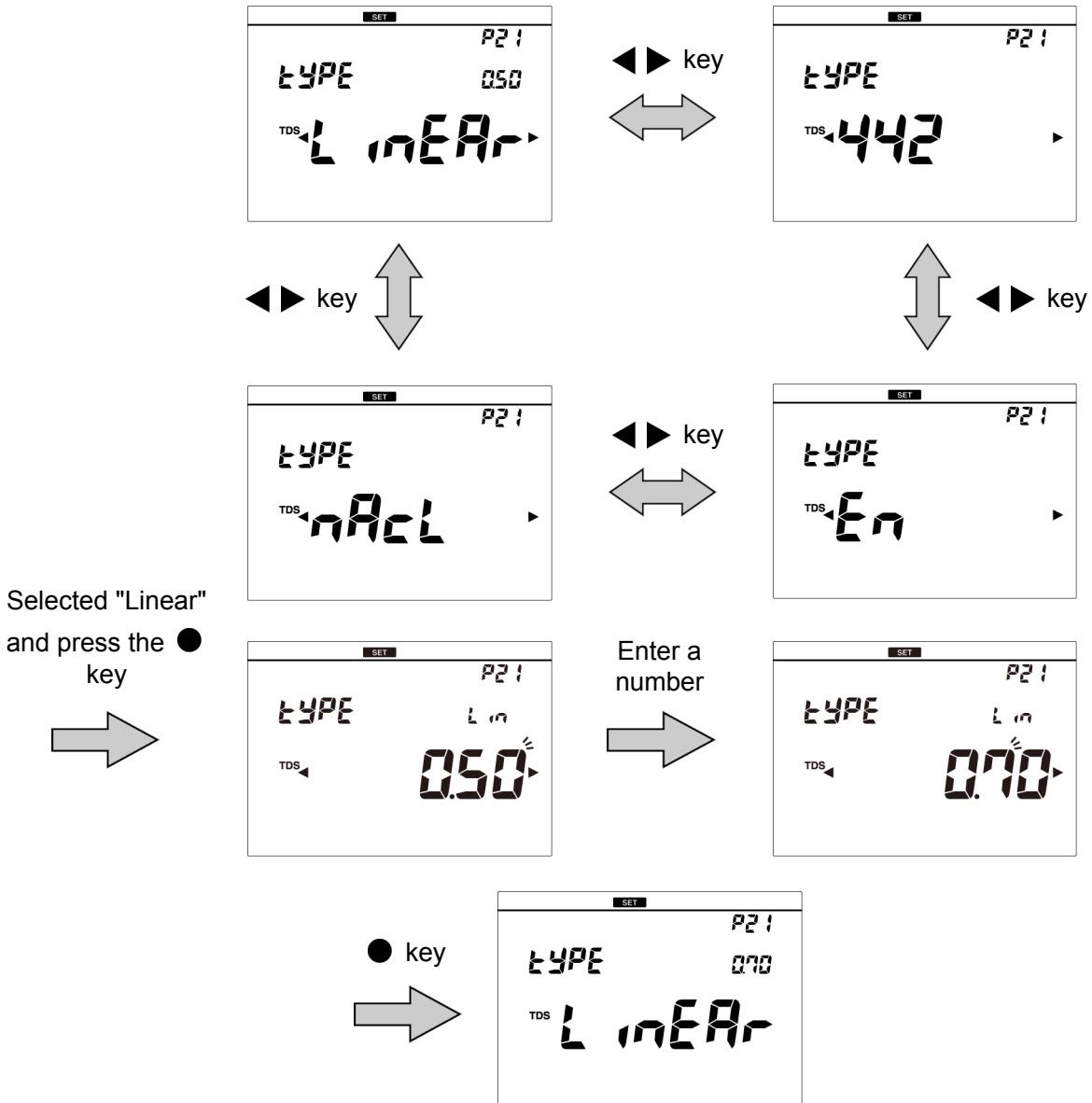



- 4. Press the ◀▶ keys to select the TDS method and then press the ● key.
- 5. When selecting "Linear," enter the factor and then press the ● key to confirm.



To return to the measurement mode, press the ↻ key.

• **Setting the salinity method** (SAL)

Salinity is calculated from the measured conductivity value. The available calibration methods are "NaCl" and "SEA WATER".

1. Press the  key to enter the setting mode.
2. Press the   keys to select "SALT" (salinity setting) and then press the  key.
3. Press the   keys to select "TYPE" (Salinity calculation method setting) and then press the  key.

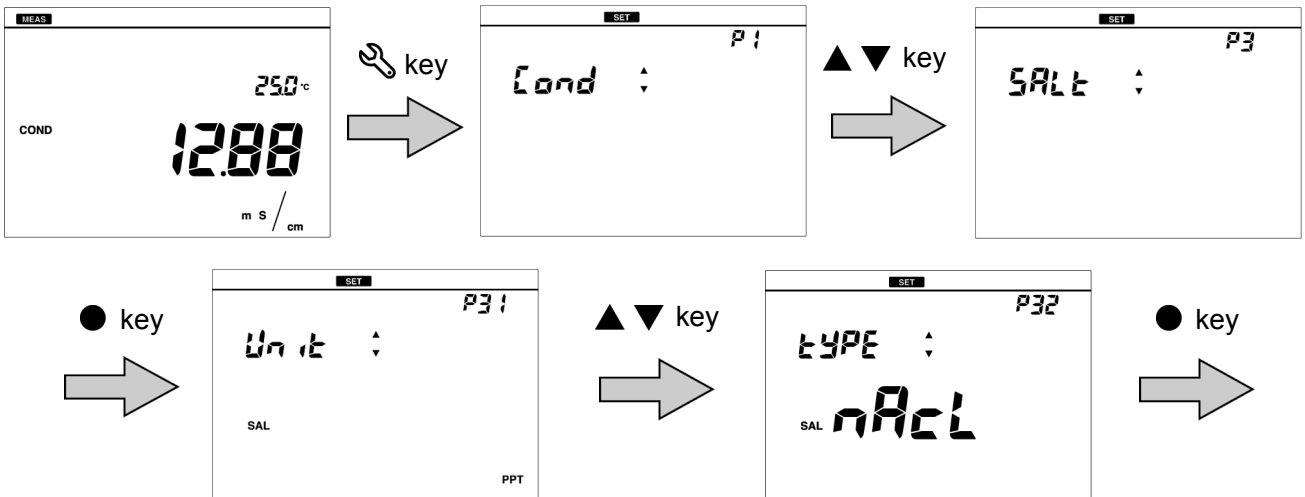

4. Press the   keys to select the salinity calculation method and then press the  key to confirm.

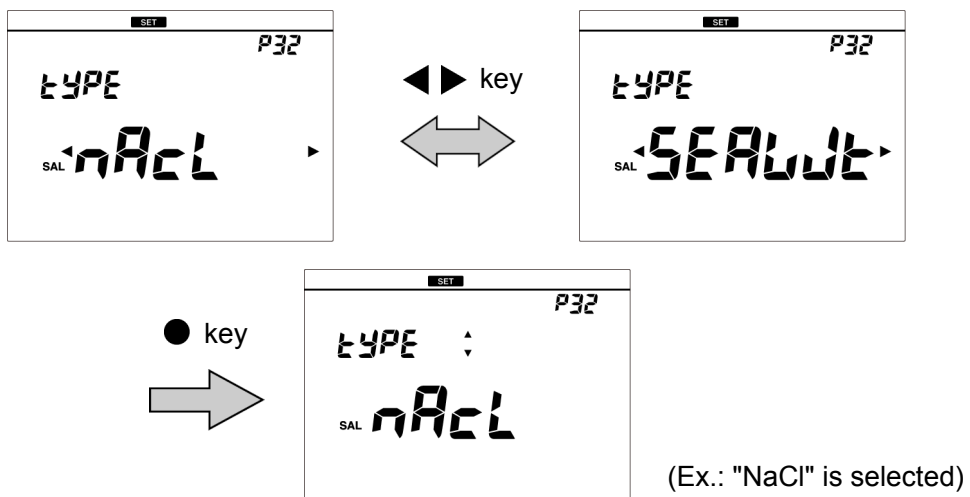

To return to the measurement mode, press the  key.

● Performing conductivity calibration

The factory-certified cell constant is indicated on the label on the electrical conductivity cell. Cell constant may change depending on the usage condition. In such case, the conductivity cell can be calibrated automatically or manually.

You can select calibration method. For how to set the mode, refer to “ Changing the calibration method ” (page 35).

• Automatic calibration

1. Clean the conductivity cell with pure water (or deionized water) and wipe it with filter paper or tissue paper.

Do not touch the black electrode part.

Refer to the instruction manual of the conductivity cell for how to clean the conductivity cell.

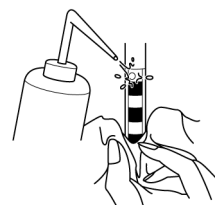

2. Immerse the conductivity cell in the standard solution.

Make sure the hole at the upper part of the cell is immersed.

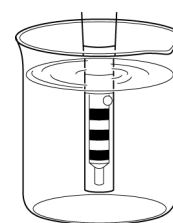

3. Press the  key to enter the calibration mode.

Stability judgment starts and the COND icon blinks. When the measured value stabilizes, the COND icon changes from the blinking state to the lit state.

4. Press the  key or  key.

The 1st point calibration ends and the calibration history icon corresponding to the calibration range lights, indicating that 1st point calibration is complete.

The display returns to the measurement screen.

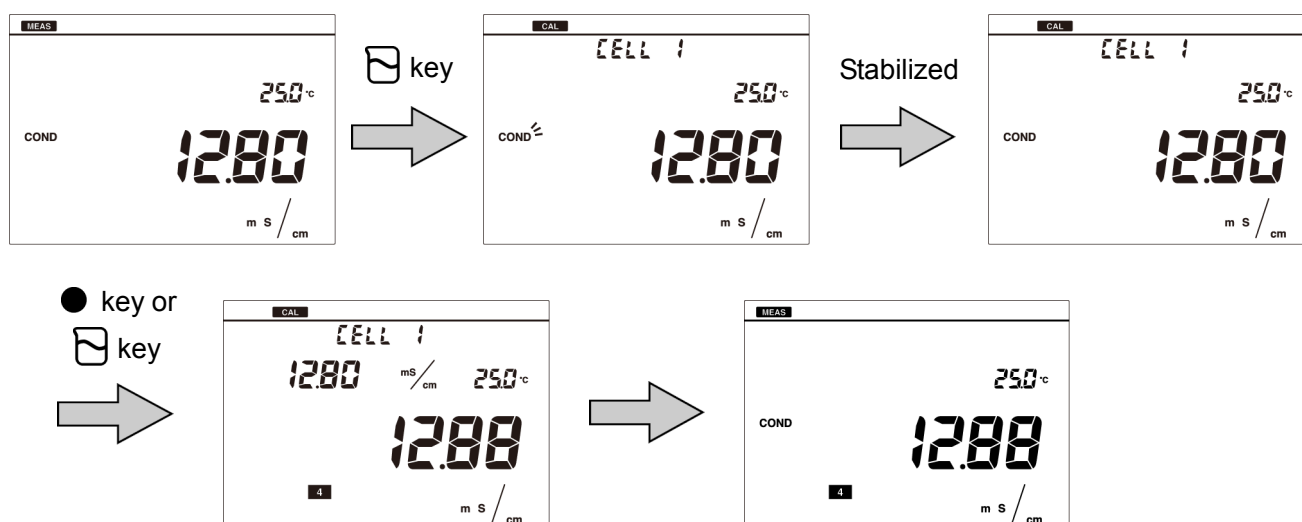

For multiple point calibration, repeat the steps 1. to 4.

Note

In automatic calibration, the measured value of a standard solution that is not at 25°C is always converted to 25°C with 2.00%/°C temperature coefficient.

• Manual calibration

1. Clean the conductivity cell with pure water (or deionized water) and wipe it with filter paper or tissue paper.

Do not touch the black electrode part.

Refer to the instruction manual of the conductivity cell for how to clean the conductivity cell.

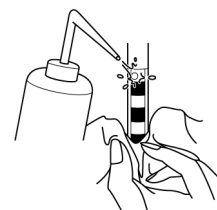

2. Immerse the conductivity cell in the standard solution.

Make sure the hole at the upper part of the cell is immersed.

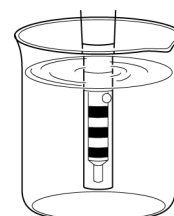

3. Press the key to enter the calibration mode.

Stability judgment starts and the COND icon blinks. When the measured value stabilizes, the COND icon changes from the blinking state to the lit state.

4. Press the keys to enter the electrical conductivity value of the standard solution used for calibration at the measured temperature.

5. Press the key or key.

Calibration to the set standard solution value at the measured temperature is performed. The 1st point calibration ends and the calibration history icon corresponding to the calibration range lights, indicating that 1st point calibration is complete.

The display returns to the measurement screen.

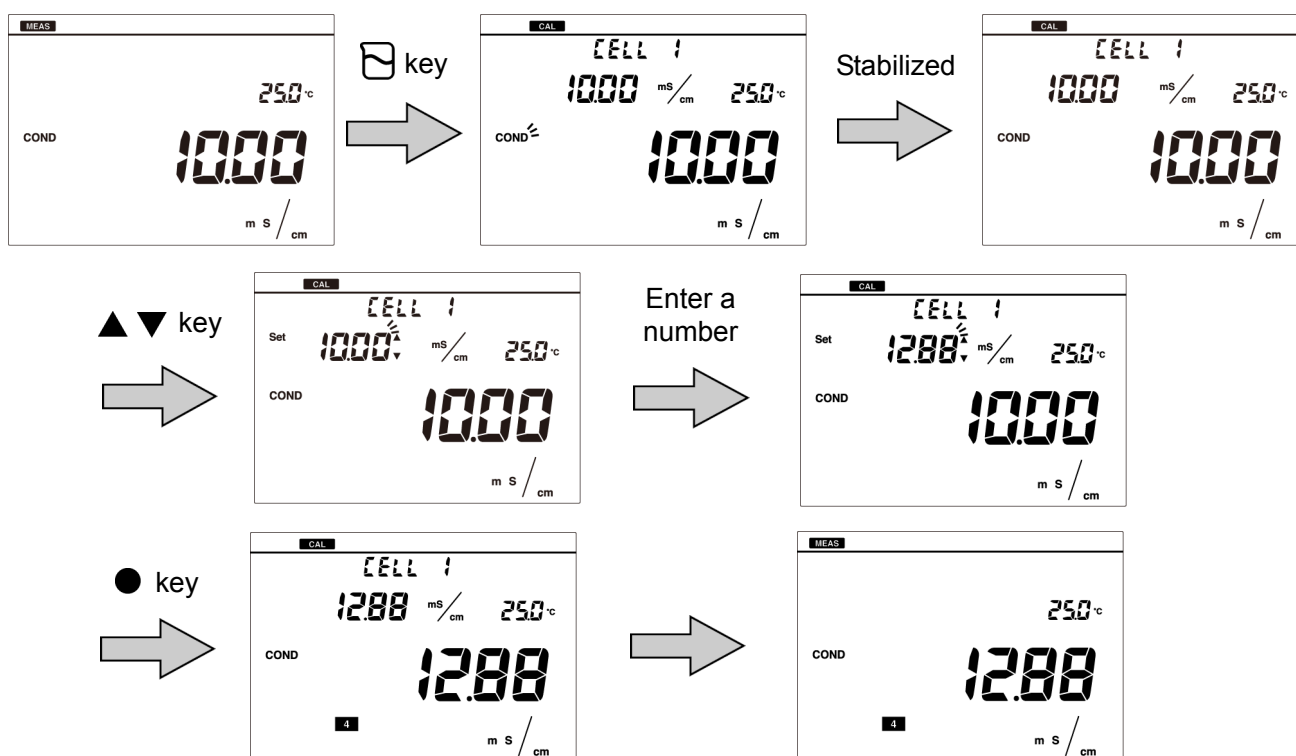

For multiple point calibration, repeat the steps 1. to 5. The calibration points are up to 5 points.

Note

The calibration for TDS, salinity, and resistivity is performed with the result of the calibration of conductivity. When pressing the  key to enter the calibration mode for TDS, salinity, and resistivity, "CAL in COND" is displayed. It indicates that performing conductivity calibration is recommended.

● Performing measurement ALL

Immerse the conductivity cell in a sample to perform measurement. The auto stability mode and the auto hold mode are available to judge the stability of the measurement value.

For details of settings, refer to “ Setting the auto stability and the auto hold function ” (page 39).

1. Press the  key to change to the measurement parameter to measure.

2. Clean the conductivity cell with pure water (or deionized water) and wipe it with filter paper or tissue paper.

Do not touch the black electrode part.

Refer to the instruction manual of the conductivity cell for how to clean the conductivity cell.

3. Immerse the conductivity cell in the sample solution.

Make sure the hole at the upper part of the cell is immersed.

Stability judgment starts and the measurement item icon blinks. When the measured value stabilizes, the measurement item icon changes from the blinking state to the lit state, and the display is fixed to the stabilized measured value.

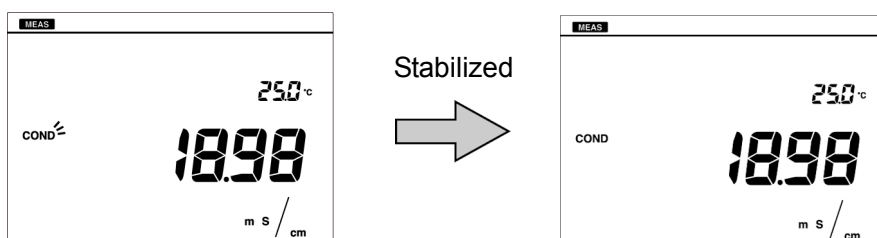
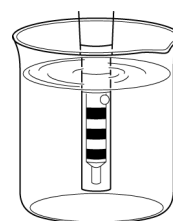
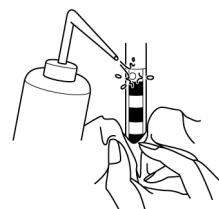

Note

- The criteria of stability judgment in the auto stability mode and the auto hold mode are as follows.

Conductivity: Display value change for 10 seconds is less than 3 digit and temperature change is less than 2.0°C.

Salinity: Display value change for 10 seconds is less than 1.0 PPT (0.1%) and temperature change is less than 2.0°C.

TDS: Display value change for 10 seconds is less than 30 mg/L and temperature change is less than 2.0°C.

Resistivity: Display value change for 10 seconds is less than 3 digit and temperature change is less than 2.0°C.

- If the measured value is above the display range, "Or" (over) appears. For details on the action to take, refer to “ The measured value is outside the display range ” (page 56).

● Saving measured values

To save the measurement data, press the ● key in the screen that you want to save. For details, refer to “ Saving measurement data in the internal memory ” (page 10).

● Printing measured values in the measurement mode

To print the measurement data, press the ► key in the screen that you want to print. For details, refer to “ Printing measured values and calibration data ” (page 46).

Using various functions





This section describes functions available in this instrument.

■ Data functions	32
● Displaying saved data.....	32
● Deleting all saved data.....	33
■ Measurement settings	34
● Displaying the latest calibration data.....	34
● Changing the calibration method	35
● Deleting calibration data.....	36
■ Temperature setting	38
● Calibrating temperature sensor	38
■ General settings	39
● Setting the auto stability and the auto hold function	39
● Resetting to factory default settings	41
● Performing test printing of the printer unit.....	42
● Setting automatic print	43
● Setting password	44
■ Other settings	46
● Printing measured values and calibration data.....	46
● Transferring saved data to a PC	49
● Operating the instrument from an external device	50

■ Data functions

● Displaying saved data

You can display the data saved in the internal memory.

1. Press the  key to enter the data mode.
2. Press the   keys to select "DAT.OUT" (display saved data) and then press the  key.

Press the   keys to change the measurement data.

When pressing the  key, the data is printed.

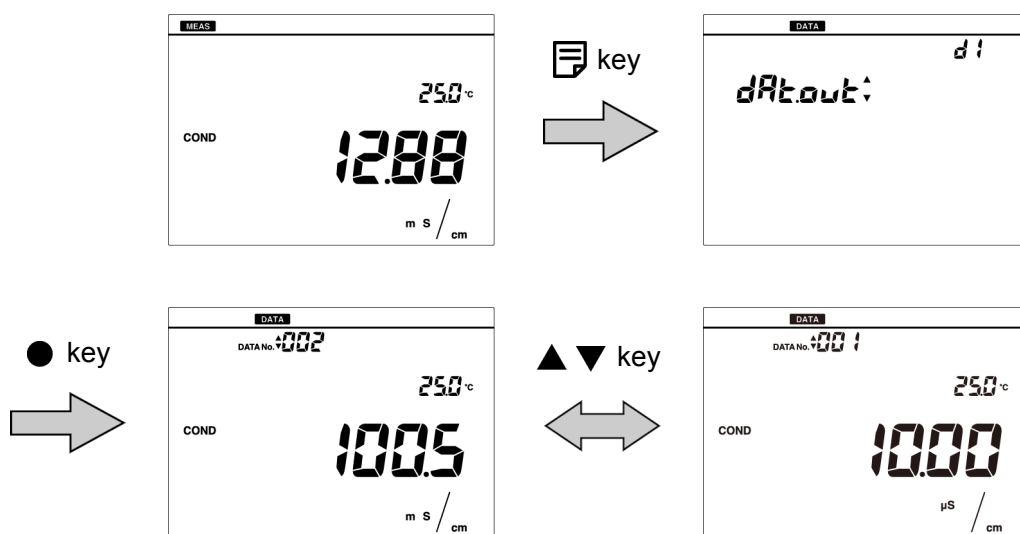

To return to the measurement mode, press the  key and then press the  key.

● Deleting all saved data

Delete all data saved in the internal memory. Data cannot be deleted selectively. Copy or transfer the data to a PC for storage if necessary.

1. Press the  key to enter the data mode.

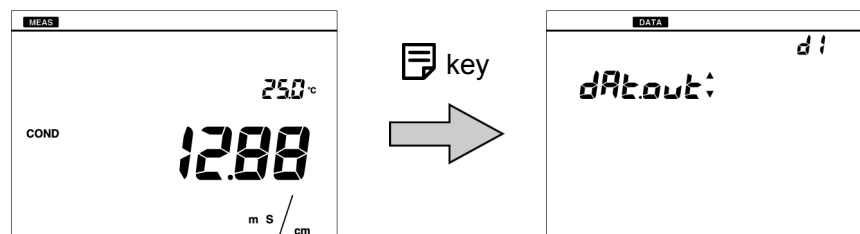

2. Press the ▲ ▼ keys to select "DAT.CLR" (delete saved data) and then press the ● key.
3. Select "YES" to delete the saved data, or select "NO" to cancel deleting it. And then press the ● key to confirm.
When "YES" is selected, "END" appears after delete is complete.

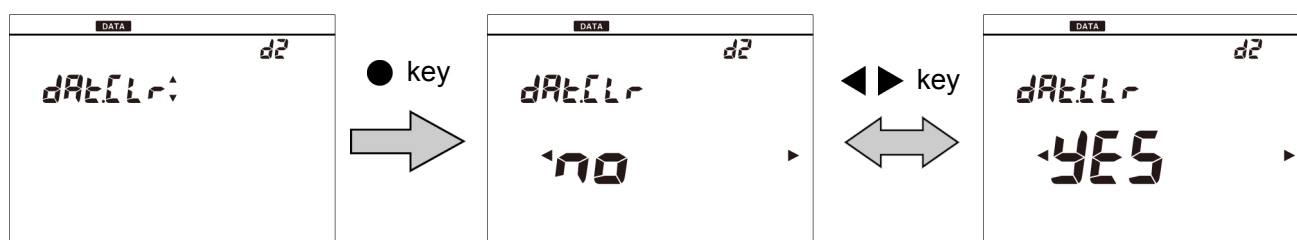

Selected "YES"
and press the
● key

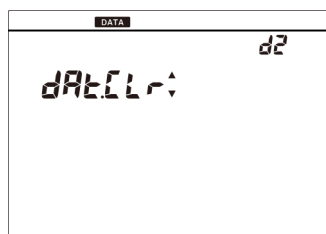
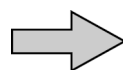
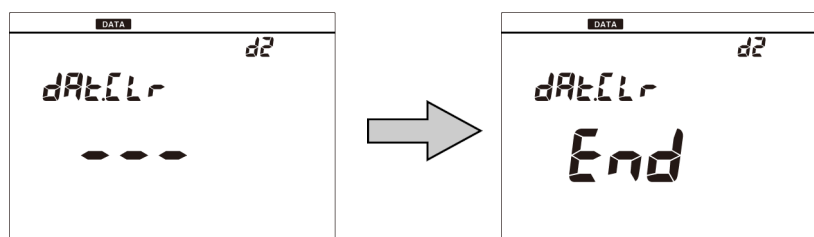
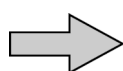









To return to the measurement mode, press the  key.

■ Measurement settings

● Displaying the latest calibration data



You can display the latest calibration data.

1. Press the  key to enter the setting mode.
2. Press the   keys to select "COND" (conductivity setting) and then press the  key.
3. Press the   keys to select "CAL.DAT" (display calibration data) and then press the  key.

The cell constants determined by calibration are displayed. Press the  key to show the cell constants in order of ranges.

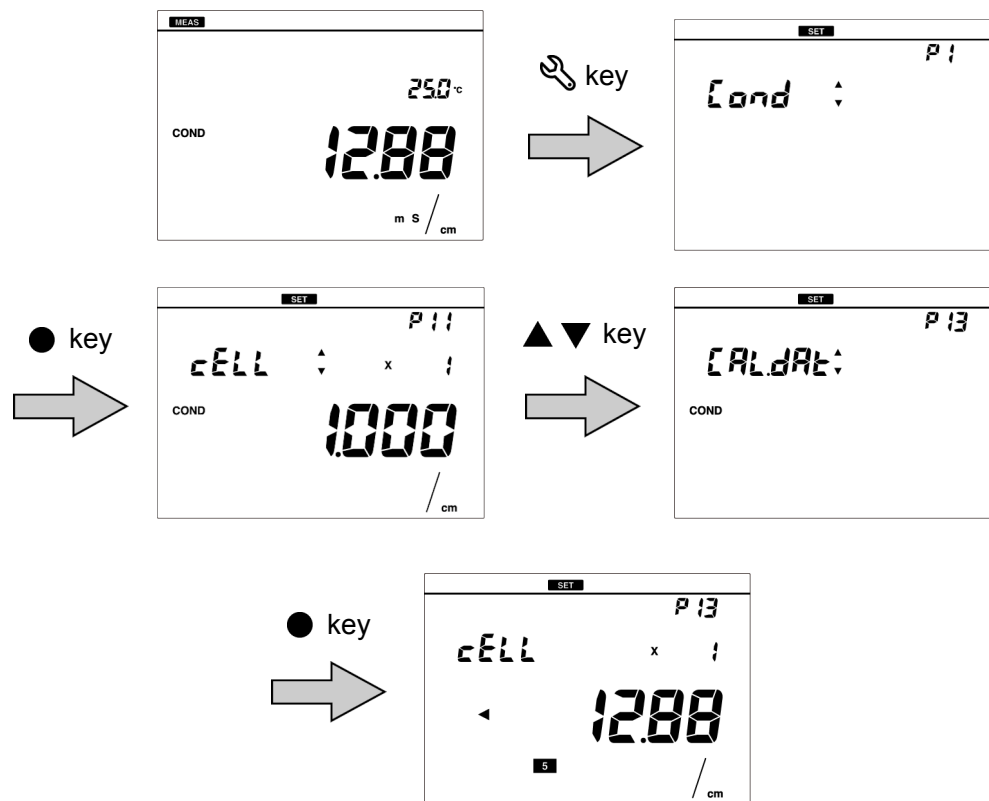







When pressing the  key in the display of cell constant, the cell constant is printed.



To return to the measurement mode, press the  key and then press the  key.

● Changing the calibration method

Select automatic calibration or manual calibration for the calibration method.

1. Press the  key to enter the setting mode.
2. Press the   keys to select "COND" (conductivity setting) and then press the  key.
3. Press the   keys to select "AT. CAL" (automatic calibration setting) and then press the  key.
4. Select "ON" to set the automatic calibration, or select "OFF" to set the manual calibration. And then press the  key to confirm.

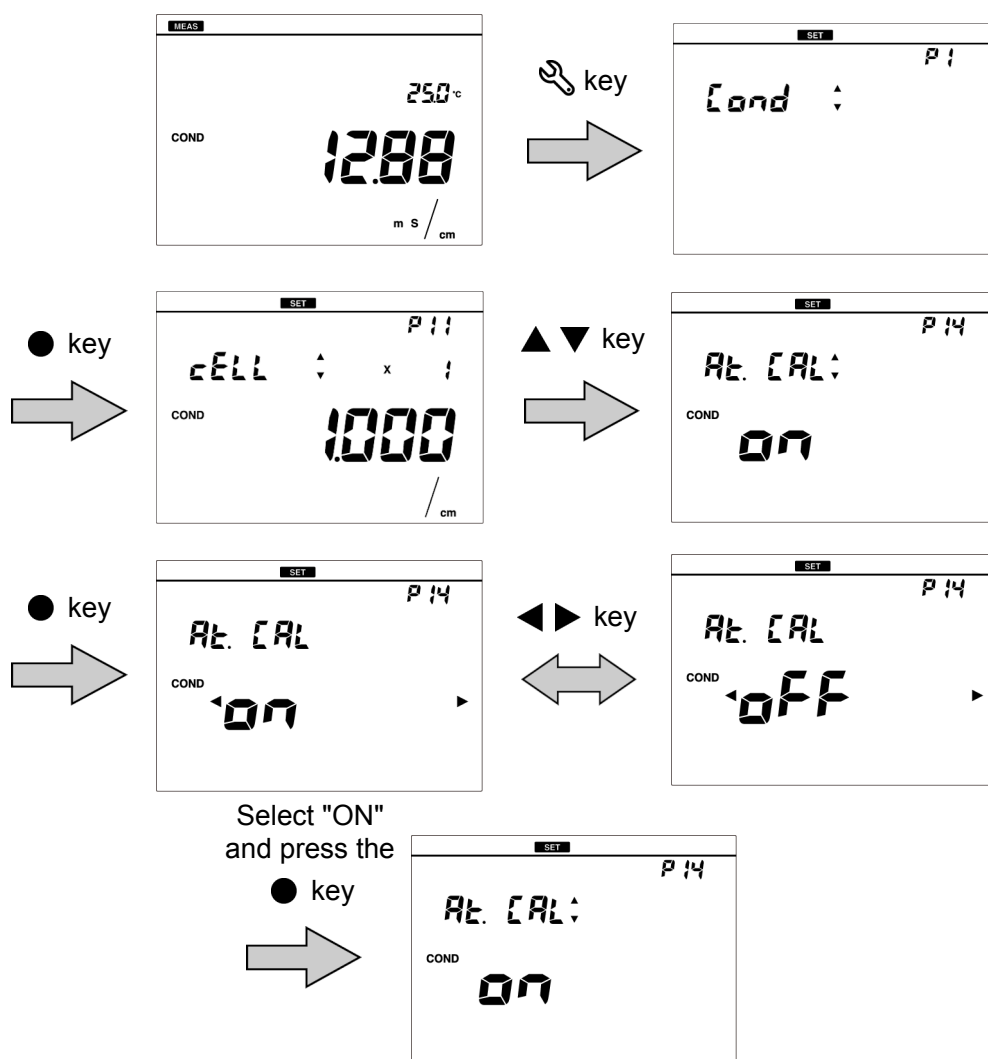







To return to the measurement mode, press the  key.

Note

When the setting of calibration method (auto or manual) is changed, the cell constant is initialized. Make sure to enter the cell constant or to perform calibration again.

● Deleting calibration data

Delete the calibration data set in the instrument.

1. Press the  key to enter the setting mode.
2. Press the   keys to select "COND" (conductivity setting) and then press the  key.
3. Press the   keys to select "CAL.CLR" (delete calibration data) and then press the  key.

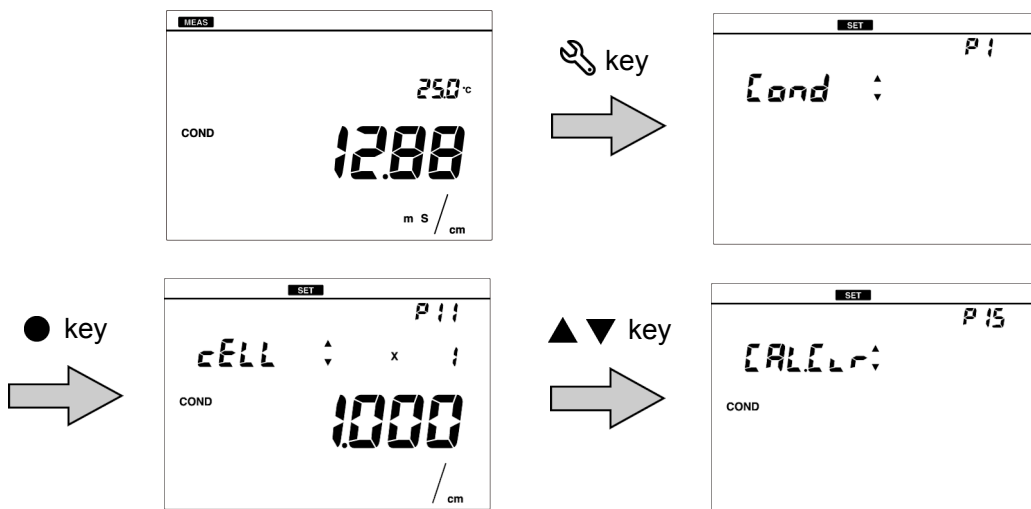

4. Select "YES" to delete the calibration data, or select "NO" to cancel deleting it.
And then press the ● key.

When "YES" is selected and the ● key is pressed, "END" appears after delete is complete.

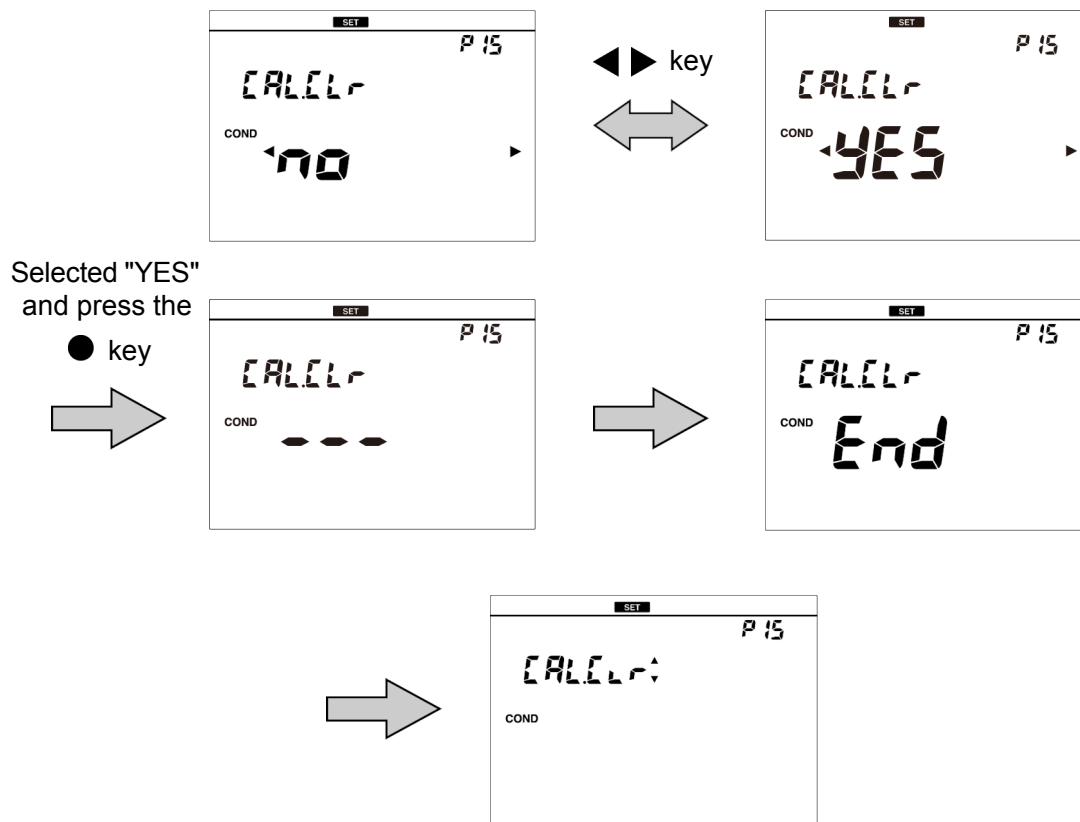

To return to the measurement mode, press the  key.





Tip

When the  key is pressed for more than three seconds in the measurement mode, "CAL.CLR" screen appears and the calibration data can be deleted.



■ Temperature setting

● Calibrating temperature sensor

The temperature sensor or temperature compensation electrode in the combination electrode has $\pm 1^{\circ}\text{C}$ accuracy without calibration. You can use a known temperature solution to calibrate the temperature sensor.

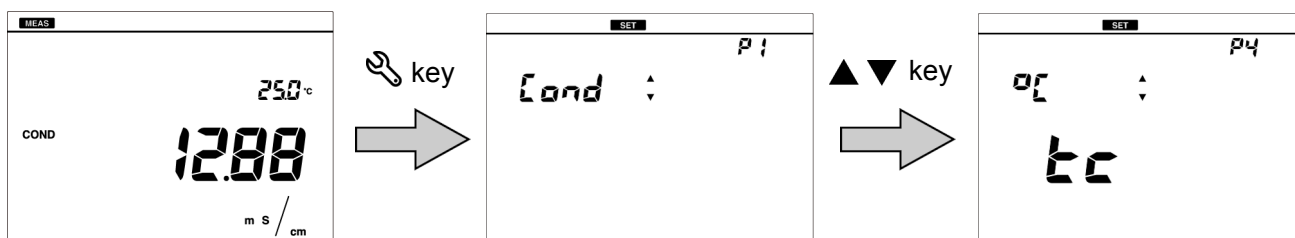
1. Insert the temperature connector into the jack of the CH2 temperature electrode (T).
2. Immerse the electrode into the solution until the temperature sensor is immersed.
3. Press the  key to enter the setting mode.
4. Press the   keys to select "TC" (temperature calibration setting) and then press the  key.



5. Make sure that "ATC" is displayed, and press the  key. The temperature setting screen appears.
6. Enter the set temperature and press the  key to confirm. The temperature sensor is calibrated.

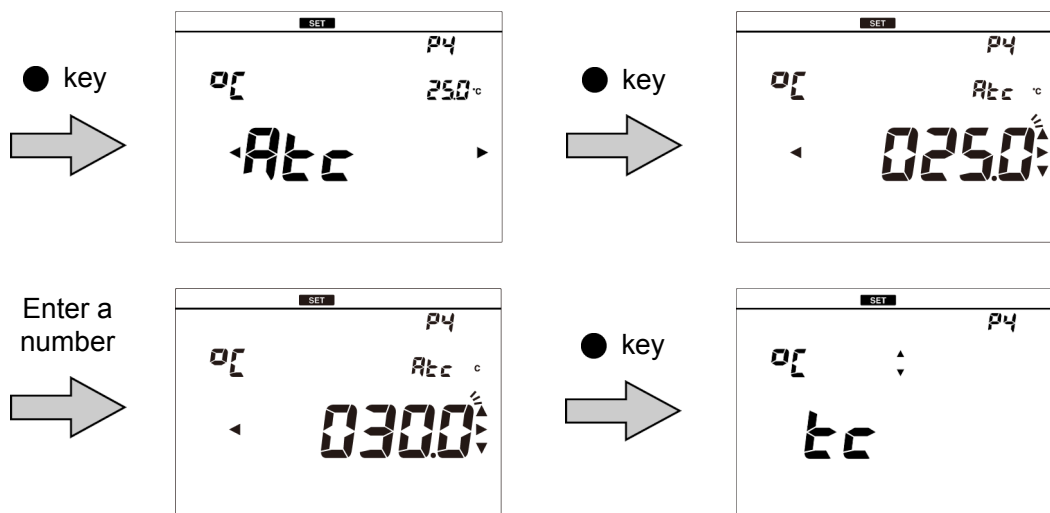

To return to the measurement mode, press the  key.

Note

When initializing temperature calibration data, all settings need to be initialized. Perform initialization by referring to "Resetting to factory default settings" (page 41). When initialization is performed, all saved data is deleted. Copy or transfer necessary data to a PC for storage.

■ General settings

● Setting the auto stability and the auto hold function

This instrument has the auto stability mode and the auto hold mode.







• Auto stability mode (displayed as AS)

When the criterion for stability judgment is fulfilled during measurement, the component icon lights and the measured value is fixed. Once the value deviates from the stability judgment criterion, the measured value is released and displays instantaneous value.

• Auto hold mode (displayed as AH)

When the criterion for stability judgment is fulfilled during measurement, the component icon and the HOLD icon light and the measured value is fixed. To release the measured value, press the  key. Once a measured value is fixed, the measured value is not released automatically even when the state deviates from the stability judgment criterion.

• Setting procedure

1. Press the  key to enter the setting mode.
2. Press the   keys to select "GEN" (general setting) and then press the  key.
3. Press the   keys to select "MEAS" (measurement setting) and then press the  key.

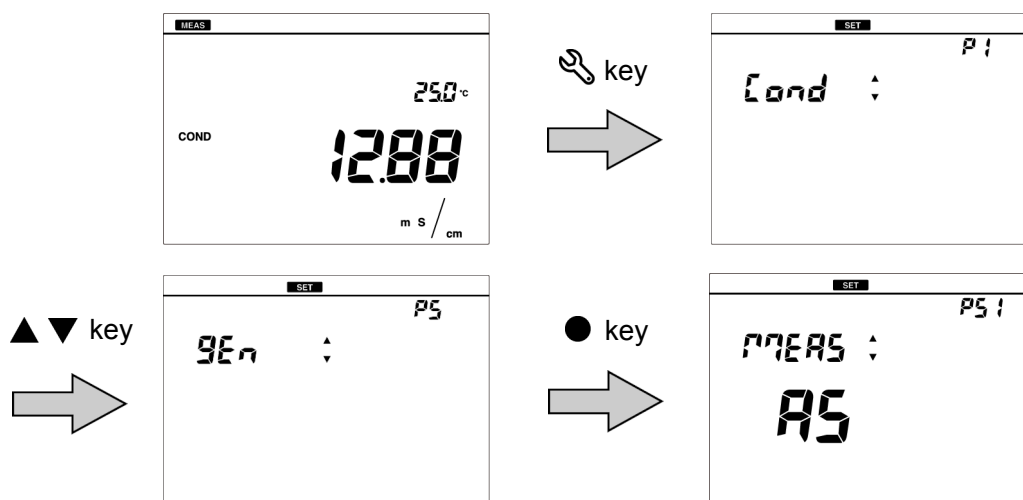

4. Select "AS" to set the automatic stability, or select "AH" to set the automatic hold. And then press the ● key to confirm.

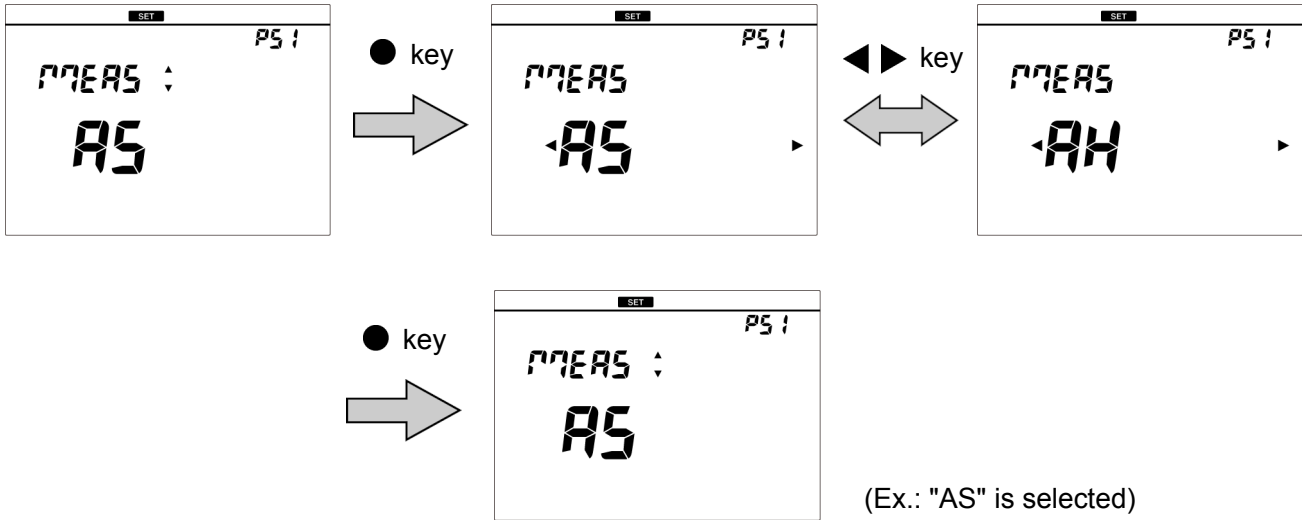

To return to the measurement mode, press the  key.

Note





In the calibration mode, the auto stability mode always works.

Tip





The stability judgment criteria is the same for both the auto stability mode and the auto hold mode.

● Resetting to factory default settings

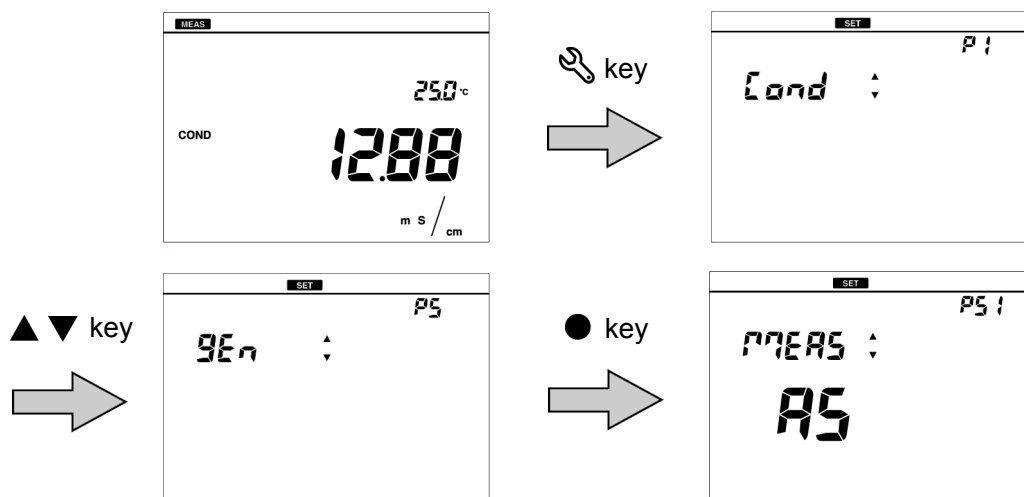
The instrument settings can be reset to the factory default settings. The calibration data and the saved data are deleted. Make sure there will be no problems before using this function. When this function is used, the temperature calibration data is also initialized.

1. Press the  key to enter the setting mode.
2. Press the   keys to select "GEN" (general setting) and then press the  key.



3. Press the   keys to select "RESET" (initialize) and then press the  key.
4. Select "YES" to initialize the settings to the factory default settings, or select "NO" to cancel initialization. And then press the  key to confirm selection. When "YES" is selected, "END" is displayed after the settings are initialized and then the instrument is automatically power OFF.

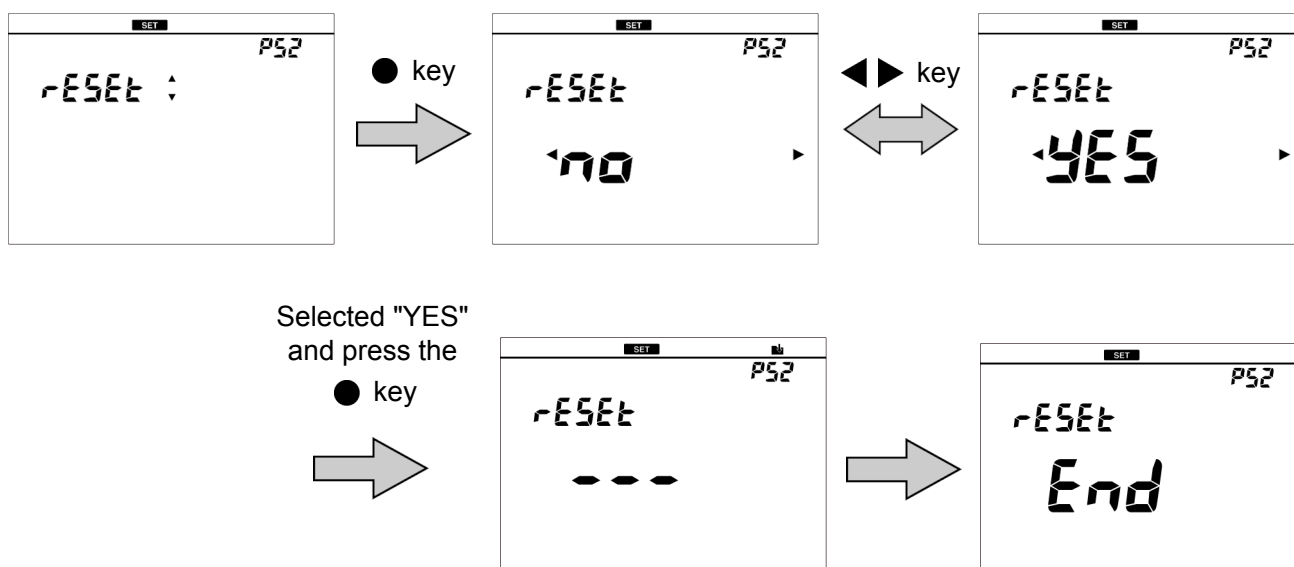





● Performing test printing of the printer unit

In order to check whether the printer unit is operating correctly or there is a printer communication problem, you can perform test printing.





Connect the instrument and a printer correctly and perform the following procedure for test printing. As a result of test printing, if the printout is as shown below, the printer unit is operating correctly.

```

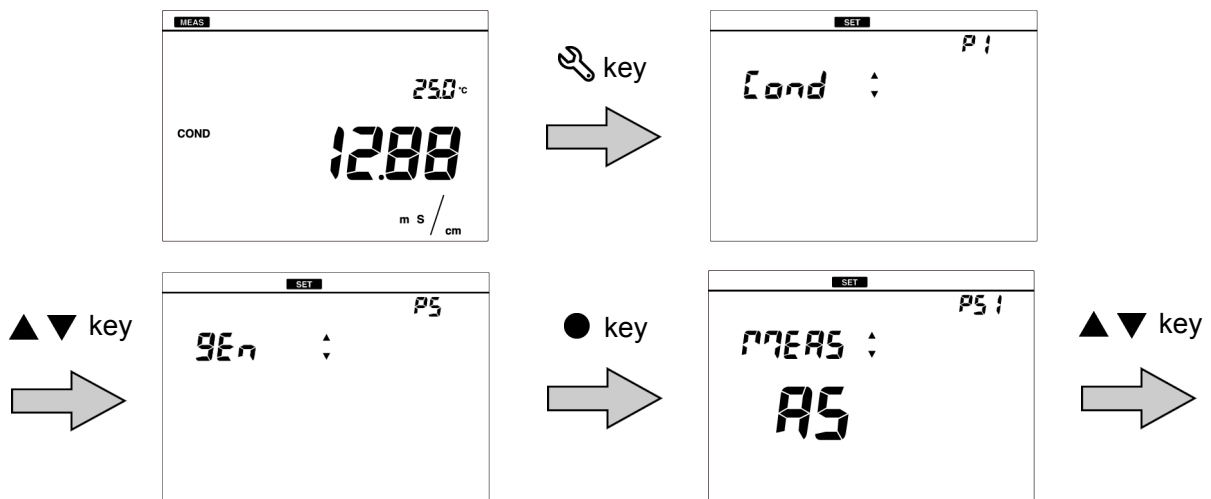
! " # $ % & ' ( ) * + , - . / 0 1 2 3
4 5 6 7 8 9 : ; < = > ? @ A B C D E F G
H I J K L M N O P Q R S T U V W X Y Z [
\ ] ^ _ ` a b c d e f g h i j k l m n o
p q r s t u v w x y z { | }
    
```

1. Press the  key to enter the setting mode.
2. Press the   keys to select "GEN" (general setting) and then press the  key.



3. Press the   keys to select "PRNT" (test print) and then press the  key.
 Printing starts automatically. When printing ends, the printer icon lights and "END" appears. Press the  key or  key.

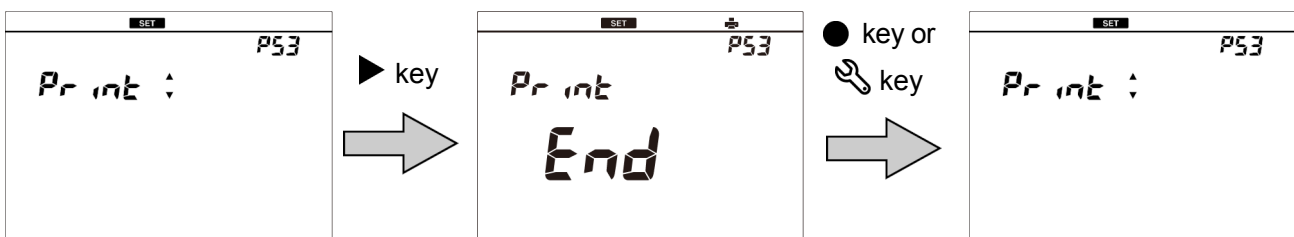

To return to the measurement mode, press the  key.

● Setting automatic print



When a printer is connected, you can enable automatic printing. When the setting is ON, printing is executed automatically under the following conditions.

- When data is saved during measurement
- When calibration is completed in the calibration screen

1. Press the  key to enter the setting mode.

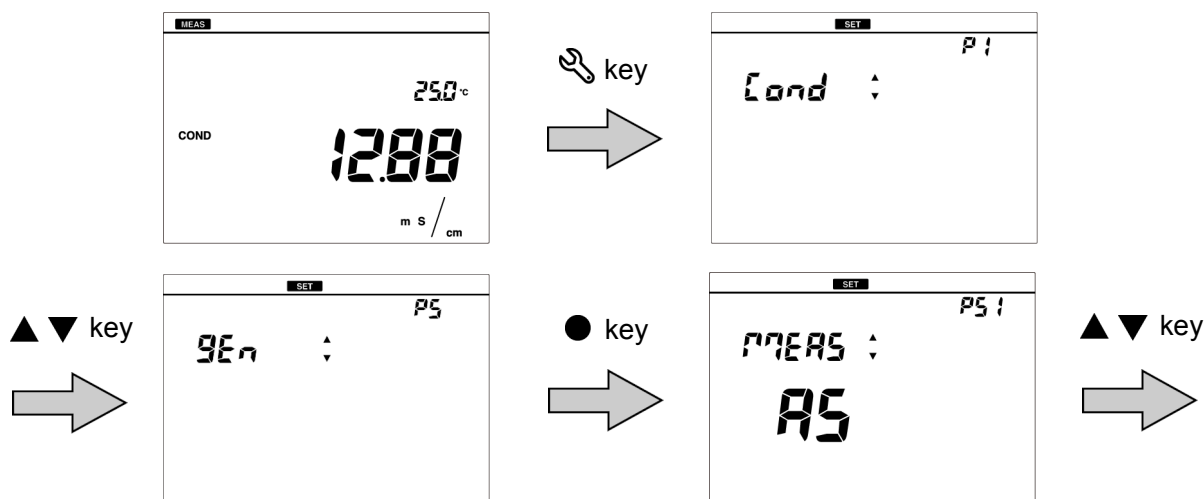
2. Press the   key to select "GEN" (general setting) and then press the  key.



3. Press the   keys to select "AT. PRN" (automatic print setting) and then press the  key.



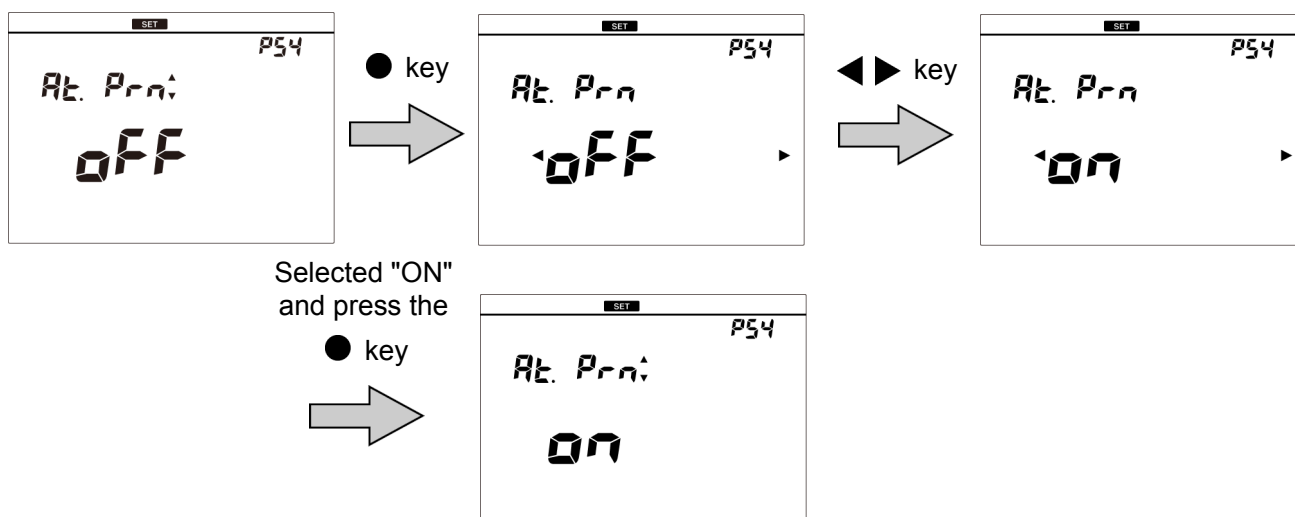

4. Select "ON" to use the function, or "OFF" to not use the function, and then press the  key to confirm selection.



To return to the measurement mode, press the  key.

● Setting password

Operation of the others can be prevented by setting password.

1. Press the  key to enter the setting mode.
2. Press the   key to select "GEN" (general setting) and then press the  key.

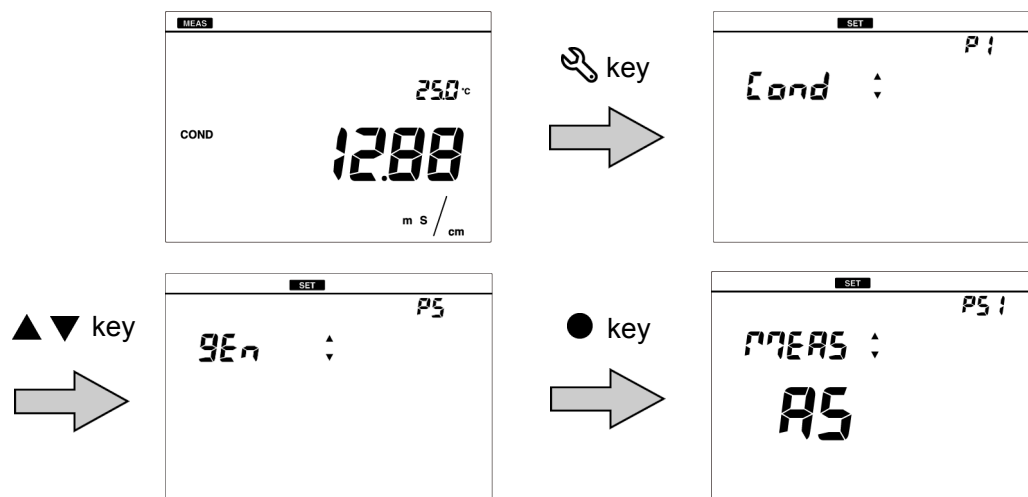

3. Press the ▲ ▼ keys to select "PASS" (password) and then press the ● key.
4. Select "ON" to use the function, or "OFF" to not use the function, and then press the ● key.
5. When selected "ON", enter a 4-digit number and press the ● key to confirm.

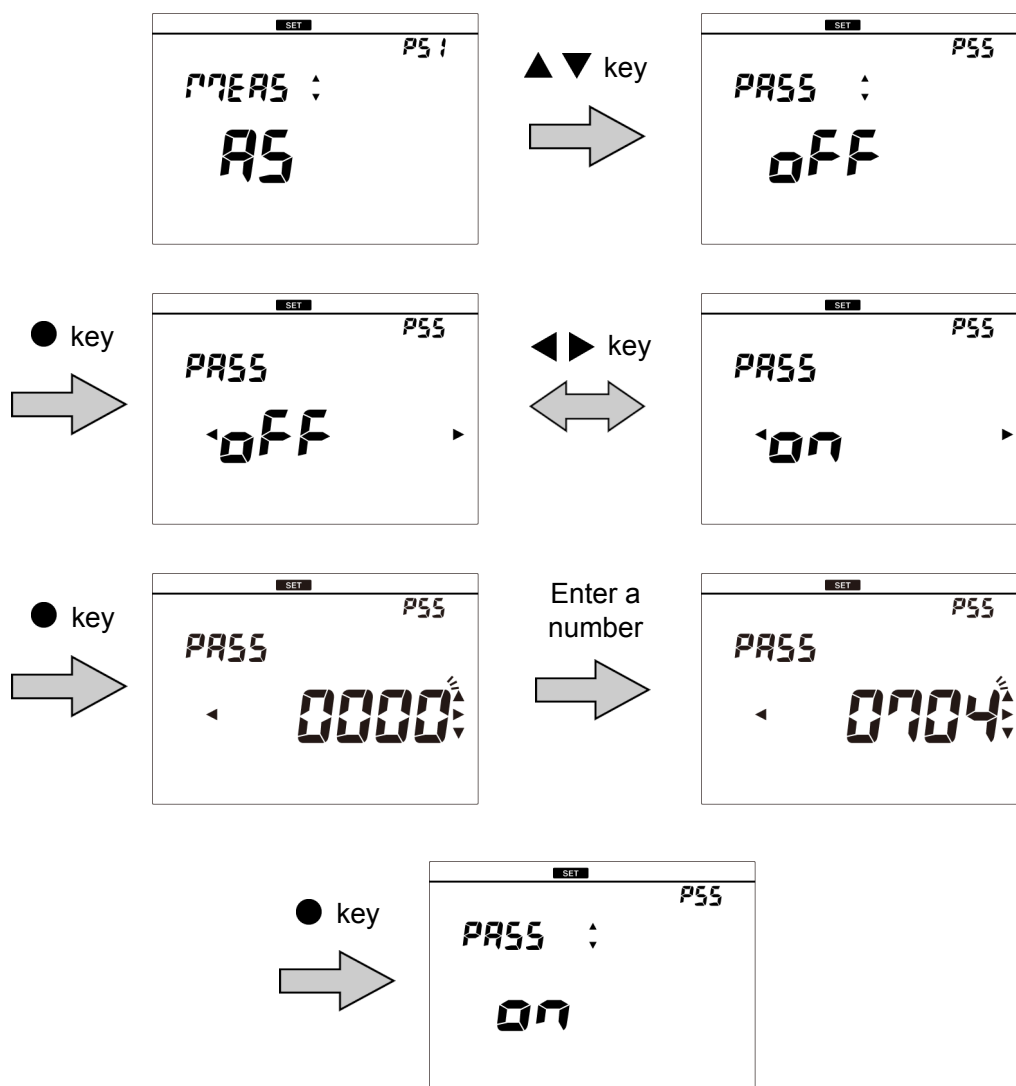

To return to the measurement mode, press the  key.

■ Other settings

● Printing measured values and calibration data

Print out the measured value or the calibrated value displayed on the instrument, or the measurement data or the calibration data saved in the instrument. If the repeatability is inspected, the inspection data is printed out with the calibration data.

Pressing the ► key starts printing during displaying the data you want to print. Use the printer cable to connect the printer unit with the instrument beforehand. If the automatic data memory is set to "ON", you cannot print out in the measurement mode.

Reference

For details of how to display measurement data and calibration data, refer to the respective section.

“ Displaying saved data ” (page 32)

“ Deleting calibration data ” (page 36)

Refer to the following table for the conductivity printout format.

< Measurement data >

Printout format	Description
COND : 1.121 mS/m	Measured value (Outside the display upper range: "Or")
HOLD : HOLD	HOLD status Hold value: HOLD Not hold value: INST
Temperature : 25.5°C ATC	Temperature value (outside the display range: "Ur" or "Or") and temperature setting
Inst. model : LAQUA-EC1100	Instrument model
Inst. SN : KL1TSE02	Instrument serial number
CELL :	Cell constant
R1 (0.00-19.99 µS/cm)	Measurement range (range 1)
1.000×1 cm ⁻¹	Cell constant (range 1)
R2 (18.0-199.9 µS/cm)	Measurement range (range 2)
1.000×1 cm ⁻¹	Cell constant (range 2)
R3 (180-1999 µS/cm)	Measurement range (range 3)
1.000×1 cm ⁻¹	Cell constant (range 3)
R4 (1.80-19.99 mS/cm)	Measurement range (range 4)
1.000×1 cm ⁻¹	Cell constant (range 4)
R5 (18.0-200.0 mS/cm)	Measurement range (range 5)
1.000×1 cm ⁻¹	Cell constant (range 5)
Temp Coef : 2.00%/°C	Temperature coefficient
Ref Temp : 25°C	Reference temperature for temperature conversion

Tip

The conductivity range marked with "O" (Ex. OR1) indicates calibrated conductivity range.

< The data saved in internal memory >

Printout format	Description
Memory Num : 0001	Data number
COND : 1.121 mS/m	Measured value (Outside the display upper range: "Or")
HOLD : HOLD	HOLD status Hold value: HOLD Not hold value: INST
Temperature : 25.0°C MTC	Temperature value (outside the display range: "Ur" or "Or") and temperature setting
Inst. model : LAQUA-EC1100	Instrument model
Inst. SN : KL1TSE02	Instrument serial number

Other settings

< Calibration data >

Printout format	Description
Inst. model : LAQUA-EC1100	Instrument model
Inst. SN : KL1TSE02	Instrument serial number
CELL :	Cell constant
R1 (0.00-19.99 $\mu\text{S/cm}$)	Measurement range (range 1)
1.000 \times 1 cm^{-1}	Cell constant (range 1)
R2 (18.0-199.9 $\mu\text{S/cm}$)	Measurement range (range 2)
1.000 \times 1 cm^{-1}	Cell constant (range 2)
R3 (180-1999 $\mu\text{S/cm}$)	Measurement range (range 3)
1.000 \times 1 cm^{-1}	Cell constant (range 3)
R4 (1.80-19.99 mS/cm)	Measurement range (range 4)
1.000 \times 1 cm^{-1}	Cell constant (range 4)
R5 (18.0-200.0 mS/cm)	Measurement range (range 5)
1.000 \times 1 cm^{-1}	Cell constant (range 5)
Calibration data	
Temp Coef : 2.00%/°C	Temperature coefficient
Ref Temp : 25°C	Reference temperature for temperature conversion
1413 $\mu\text{S/cm}$:	Calibration value
: 25.0°C ATC	Calibration Temperature and temperature setting
111.8 mS/cm :	Standard value
: 25.0°C ATC	Calibration Temperature and temperature setting

Tip

The conductivity range marked with "O" (Ex. OR1) indicates calibrated conductivity range.

● Transferring saved data to a PC

By using a serial cable or USB cable to connect the instrument to a PC, you can transfer the saved data to the PC and edit it. Connect the RS-232C connector at the instrument side to the serial port on the PC or connect the USB connector at the instrument side to the USB port on the PC.

To save and edit data, please download the software "FD-70" from our website after the registration. (The "FD-70" will be available at the end of February 2016.)

For details of how to use the "FD-70", refer to the "FD-70" instruction manual, which you can download from our website as well.

The required PC specifications and recommended PC specifications for using the "FD-70" are shown in the following table.

Item	Required PC specifications	Recommended PC specifications
Memory	32 bit: 1 GB or more 64 bit: 2 GB or more	
CPU	1 GHz or more	
HDD free space	5 GB or more	10 GB or more
OS	Windows 7, Windows 8 (8.1), or Windows 10	
Display	Super VGA (800 × 600) or more	
Connector	Serial connector (D-Sub 9 pin)	

Note

- If you are not using the RS-232C or USB communication, close the connector cover tightly.
- While using the RS-232C or USB communication, the instrument is not dust-proof. Do not use the RS-232C or USB communication in a dusty place or with wet hands.

● Operating the instrument from an external device

You can remotely operate the instrument from an external device (such as PC) via RS-232C communication or USB communication. Use a serial cable or a USB cable to connect the serial connector or the USB connector on the instrument and the serial port or the USB port on the PC.

When using this function, pay attention to the following points.

- Use the optional serial cable or USB cable to connect the unit to a PC.
- Make sure that the transfer formats used in the instrument and a PC are the same. When different transfer formats are used, a communication error occurs and the online mode does not start up, and as a result RS-232C communication cannot be performed. Also, when the transfer format is changed, turn OFF the power of the instrument and PC and then reboot them.

The transfer format of the instrument is as follows.

- Baud rate: 2400 bps
- Character length: 8 bits
- Parity: None
- Stop bit: 1 bit

You can download a list of communication commands from our website. In order to download the list, you need to complete user registration.

Note

- If you are not using the RS-232C or USB communication, close the connector cover tightly.
 - While using the RS-232C or USB communication, the instrument is not dust-proof. Do not use the RS-232C or USB communication in a dusty place or with wet hands.
-

Maintenance

This section describes maintenance of the instrument and the electrodes that are used with the instrument. To use them for a long period, perform the described maintenance procedures appropriately.

● Contact for maintenance

Please contact your dealer for the product maintenance.

● Maintenance and storage of the instrument

- If the instrument becomes dirty, wipe it gently with a soft dry cloth. If it is difficult to remove the dirt, wipe it gently with a cloth moistened with alcohol.
- The instrument is made of solvent resistant materials but that does not mean it is resistant to all chemicals. Do not dip the instrument in strong acid or alkali solution, or wipe it with such solution.
- Do not wipe the instrument with a polishing powder or other abrasive compound.

● Environmental conditions for storage

Temperature: 0°C to 45°C

Humidity: under 80% in relative humidity and free from condensation

Avoid the following conditions.

- Dusty place
- Strong vibration
- Direct sunlight
- Corrosive gas environment
- Close to an air-conditioner
- Direct wind

● Maintenance and storage of the conductivity cell

For the detailed procedures for maintaining and storing cells, refer to the instruction manual for each cells. This section describes an overview of the procedures for maintenance and storage to be performed as part of daily use.

• How to clean the cell

Always clean the cell in pure water (or deionized water) after every measurement. When the response is slow or residue from the sample adheres to the cell, use the appropriate method below to clean the cell, and then clean again with pure water (or deionized water).

Type of dirt	Cleaning solution
General	Diluted neutral cleaning solution
Inorganic substance	Ethanol (keep the ethanol away from plastic parts)
Scale that formed during long term storage	A commercially available scale remover (neutral cleansing solution for kitchen use, etc.) diluted by a factor of 100. If this does not remove the scale, use diluted solution that contains oxygen bleach (sodium percarbonate) or chlorine bleach (sodium hypochlorite).

• Daily storage of the cell

If the cell is stored in a dry state, the cell constant will change. Store with the black electrode part immersed in pure water (or deionized water), or with the protective cap filled with pure water (or deionized water) and attached to the cell.

• When the electrode will not be used for a long period

To store the cell for a long period, clean it well and attach the protective cap filled with pure water (or deionized water).

How to resolve errors or troubles

This section describes the causes of typical problems and the actions to be taken, including questions frequently asked by customers. Check these before contacting us.

■ When an error message appears

If "ERROR No.00XX" is displayed while you are using the instrument, check the error in the error list below to check the cause and action to be taken.

ERROR No.	Description	Definition of error
0001	Memory error	Data cannot be read from or written to the internal memory.
0006	Maximum calibration points exceeded	6th point calibration is attempted.
0009	Printer error	There is a problem with the printer.
0010	Memory full	The number of the data saved has exceeded the limit of the internal memory.
0011	Cell constant is out of range	Cell constant is out of automatic calculation range.

● ERROR No.0001 Memory error

Data cannot be read from or written to the internal memory.

Cause	How to solve problem
The instrument does not start properly due to noise or other at power ON.	Disconnect the AC adapter, and then press the  key.
The defect of the internal IC	Contact your dealer for repair.

● ERROR No.0006 Maximum calibration points exceeded

Attempted to perform 6th point calibration during conductivity calibration.

Cause	How to solve problem
6th point calibration is attempted.	Up to five points can be calibrated.

● **ERROR No.0009 Printer error**

An error occurred during printer communication.

Cause	How to solve problem
There is a problem with the printer unit connection.	Check the printer connection, and connect the instrument and printer again.
The defect of the printer	Consult your dealer.

● **ERROR No.0010 Memory full**

Attempted to save more than 500 items of data.

Cause	How to solve problem
Saving more than 500 items of data is attempted.	The maximum number of savable items of data is 500. Copy or transfer necessary data to a PC and delete the data from the memory (refer to “Deleting all saved data” (page 33)).

● **ERROR No.0011 Cell constant is out of range**

Cell constant is out of setting range.

Cause	How to solve problem
End of cell life	Replace the conductivity cell.
There is a problem with the standard solution	Use new standard solution.

■ Troubleshooting

This section describes causes and actions to take for problems that customers frequently ask us.

● The indicated value fluctuates

< Problem with the electrode >

Cause	How to solve problem
The conductivity cell is dirty.	Clean the conductivity cell.
The conductivity cell is broken.	Replace the conductivity cell.
There are air bubbles on the conductivity cell.	Shake the conductivity cell to remove the air bubbles.

< Problem with the instrument >

Cause	How to solve problem
There is a motor or other device causing electrical interference.	Measure at a place where no influence from induction is given. Ground all AC-powered equipment.
The conductivity cell is not connected correctly.	Connect the conductivity cell correctly.

< Problem with the sample >

Cause	How to solve problem
Some effects of the sample	Response time may slow down, depending on the properties of the sample solution.

● The response is slow

Cause	How to solve problem
The conductivity cell is dirty.	Clean the conductivity cell.
The conductivity cell is broken.	Replace the conductivity cell.
Some effects of the sample	Response time may slow down, depending on the properties of the sample solution.

● **The indicated value does not change/No response**

Cause	How to solve problem
The conductivity cell is broken.	Replace the conductivity cell.
The conductivity cell is not connected correctly.	Connect the conductivity cell correctly.
The instrument is in HOLD state.	Cancel the HOLD state.
Instrument defect	Consult your dealer.

● **The measured value is outside the display range**

When the measured value is below the display range, "Ur" appears. When the measured value is over the display range, "Or" appears.

Cause	How to solve problem
Sample is out of the measurement range.	Use a sample within the measurement range.
The conductivity cell cable is broken.	Replace the conductivity cell.
Cell constant is not set.	Set the cell constant.
Calibration is not performed or performed incorrectly.	Perform calibration correctly.
Instrument defect	Check as explained below.

● **Repeatability of the measured value is poor**

Cause	How to solve problem
Effect of the sample solution	Repeatability becomes poor when the conductivity of the sample changes over time.
The conductivity cell is dirty.	Clean the conductivity cell.
The conductivity cell is broken.	Replace the conductivity cell.

● **Nothing appears when the power is turned ON**

Cause	How to solve problem
Power is not supplied.	Connect the AC adapter.
Instrument defect	Consult your dealer.

● **Part of the display is missing**

Cause	How to solve problem
Instrument defect	Check the display in full screen state when turning ON the power of the instrument.

MEMO

Appendix

This section describes the specifications of the instrument, default settings, measurement principles, and other technical information.

Options for the instrument are also described.

■ Main specifications

Item	Contents
Model	LAQUA-EC1100
Measurement parameters	Conductivity, salinity, TDS, resistivity, temperature
Operating ambient temperature, humidity	0°C to 45°C 80% or less in relative humidity (no condensation)
Power	AC adapter 100 V to 240 V, 50/60 Hz
Dimensions	Approx. 170 (W) × 174 (D) × 73 (H) mm
Mass	Approx. 500 g

• Specification of each measurement parameters

Measurement parameter	Item	Description
Temperature	Measuring principle	Thermistor method
	Display range	-30.0°C to 130.0°C
	Measuring range	0.0°C to 100.0°C
	Resolution	0.1°C
	Accuracy	±0.4°C
	Repeatability	±0.2°C
Conductivity	Measuring principle	2 AC bipola method
	Measuring range (Display range)	Cell constant 1 cm ⁻¹ : 0.00 μS/cm to 200.0 mS/cm Cell constant 0.1 cm ⁻¹ : 0.000 μS/cm to 20.00 mS/cm Cell constant 10 cm ⁻¹ : 0.0 μS/cm to 2.000 S/cm
	Resolution	0.05% of full scale
	Accuracy	±0.6% of full scale (18.0 mS/cm to 200.0 mS/cm: ±1.5% of full scale)
	Repeatability	±0.6% of full scale
Salinity	Measuring principle	Conversion from conductivity value
	Measuring range (Display range)	0.000% to 10.000% (0.00 ppt to 100.00 ppt)
	Accuracy	±0.2% of full scale
	Resolution	0.001% (0.01 ppt)

Main specifications

Measurement parameter	Item	Description
TDS	Measuring principle	Conversion from conductivity value
	Measuring range (Display range)	0.00 mg/L to 100 g/L
	Accuracy	±0.1% of full scale
	Resolution	0.01 mg/L
Resistivity	Measuring principle	Conversion from conductivity value
	Measuring range (Display range)	Cell constant 1 cm ⁻¹ : 0.000 kΩ·cm to 20.00 MΩ·cm Cell constant 0.1 cm ⁻¹ : 0.00 kΩ·cm to 200.0 MΩ·cm Cell constant 10 cm ⁻¹ : 0.0 Ω·cm to 2.000 MΩ·cm
	Resolution	0.05% of full scale
	Accuracy	±0.6% of full scale (1.80 MΩ·cm to 20.00 MΩ·cm: ±1.5% of full scale)
	Repeatability	±0.6% of full scale ±1 digit

Tip

Accuracy is the difference between the measured value and the simulation value when the simulation value is inputted to the instrument.

● Table of conductivity cell range

• Unit: S/m

Range	Cell constant		
	1000 m ⁻¹	100 m ⁻¹	10 m ⁻¹
20.0 to 200.0 S/m			
2.00 to 19.99 S/m			
0.200 to 1.999 S/m			
20.0 to 199.9 mS/m			
2.00 (0.00) to 19.99 mS/m			
0.200 (0.000) to 1.999 mS/m			
0.0 to 199.9 μS/m			

• Unit: S/cm

Range	Cell constant		
	10 cm ⁻¹	1 cm ⁻¹	0.1 cm ⁻¹
0.200 to 2.000 S/cm			
20.0 to 199.9 mS/cm			
2.00 to 19.99 mS/cm			
200 to 1999 μS/cm			
20.0 (0.0) to 199.9 μS/cm			
2.00 (0.00) to 19.99 μS/cm			
0.000 to 1.999 μS/cm			

• Unit: mS/cm FIX

Range	Cell constant		
	10 cm ⁻¹	1 cm ⁻¹	0.1 cm ⁻¹
200.0 to 2000 mS/cm			
20.00 to 199.9 mS/cm			
2.000 to 19.99 mS/cm			
0.200 (0.000) to 1.999 mS/cm			
0.020 (0.000) to 0.199 mS/cm			
0.002 to 0.019 mS/cm			
0.000 to 0.002 mS/cm			

● **Table of conductivity cell range (resistivity range)**

• Unit: $\Omega \cdot m$

Range	Cell constant		
	$10 m^{-1}$	$100 m^{-1}$	$1000 m^{-1}$
0.200 to 2.000 $M\Omega \cdot m$			
20.0 to 199.9 $k\Omega \cdot m$			
2.00 to 19.99 $k\Omega \cdot m$			
0.200 to 1.999 $k\Omega \cdot m$			
20.0 (0.0) to 199.9 $\Omega \cdot m$			
2.00 (0.00) to 19.99 $\Omega \cdot m$			
0.000 to 1.999 $\Omega \cdot m$			

• Unit: $\Omega \cdot cm$

Range	Cell constant		
	$0.1 cm^{-1}$	$1 cm^{-1}$	$10 cm^{-1}$
20.0 to 200.0 $M\Omega \cdot cm$			
2.00 to 19.99 $M\Omega \cdot cm$			
0.200 to 1.999 $M\Omega \cdot cm$			
20.0 to 199.9 $k\Omega \cdot cm$			
2.00 (0.00) to 19.99 $k\Omega \cdot cm$			
0.200 (0.000) to 1.999 $k\Omega \cdot cm$			
0.0 to 199.9 $\Omega \cdot cm$			

■ **Functions**

Item	EC1100
Clock	-
Memory number	500
Auto data memory	-
Printer connection	✓
PC connection	✓

■ Instrument default settings

Measurement parameter	Item	Selection item/Setting range	Default values
Common	Auto hold	AS/AH	AS
	Temperature input value	0.0°C to 100.0°C	25.0°C
	Auto power off time	0 min to 30 min * ¹	30 min
	Auto data memory time	0, 2 s to 3600 s * ²	2 s
Conductivity	Cell constant	0.700 to 1.300 (0.1 cm ⁻¹ , 1 cm ⁻¹ , 10 cm ⁻¹)	1.000 (1 cm ⁻¹)
	Temperature coefficient	0.00%/°C to 10.00%/°C	2.00%/°C
	Unit	S/cm, S/m, mS/cm FIX	S/cm
	Calibration method	Auto/Manual	Auto
	Reference temperature	15°C to 30°C	25°C
Salinity	Unit	PPT, %	PPT
	Calculation method	NaCl/Sea water	NaCl
TDS	Calculation method	linear/442/En/NaCl	linear

*1: When 0 is inputted, auto power OFF is OFF.

*2: When 0 is inputted, auto data memory is OFF.

■ Technical note

● Conductivity standard values at various temperatures

Temp. (°C)	Conductivity value at 25°C			
	84.00 (μS/cm)	1413 (μS/cm)	12.88 (mS/cm)	111.8 (mS/cm)
0	64.01	776	7.15	65.4
5	65.00	896	8.22	74.1
10	67.00	1020	9.33	83.2
15	68.00	1147	10.48	92.5
16	70.00	1173	10.72	94.4
17	71.00	1199	10.95	96.3
18	73.00	1225	11.19	98.2
19	74.00	1251	11.43	100.2
20	76.00	1278	11.67	102.1
21	78.00	1305	11.91	104.0
22	79.00	1332	12.15	105.9
23	81.00	1359	12.39	107.9
24	82.00	1386	12.64	109.8
25	84.00	1413	12.88	111.8
26	86.00	1440	13.13	113.8
27	87.00	1467	13.37	115.7
28	89.00	1494	13.62	117.7
29	90.00	1521	13.87	119.7
30	92.00	1548	14.12	121.8
31	94.00	1575	14.37	123.9

Options

■ Options

A wide variety of electrodes and options are available for use with the instrument. You can select the optimum electrode and options for your application and objectives.

These options can be purchased from your nearest agency. Please provide the part name and part number to the representative.

With regard to electrodes, it is important to select the optimum electrode for the sample you want to measure. For details, refer to the catalogue or our website, or contact your dealer.

Part name		Part number	Remarks
Plain paper printer	Printer (USA, 120 V)	3014030146	Printer cable sold separately
	Printer (EU, 230 V)	3014030147	
	Printer cable	3014030148	1.5 m
	Roll paper	3014030149	20 rolls/set
	Ink ribbon	3014030150	5 pcs/set
Serial cable		3014030151	1.5 m
USB cable		3200373941	1 m
Electrode stand (model FA-70A)		3200644455	