

**HORIBA**  
Scientific

# LAQUA



pH	ORP	Ion	Conductivity
Resistivity	TDS	DO	Salinity

Handheld Water Quality Meters  
100 Series

# LAQUA

In the lab, in the field or anywhere you need it  
100 Series Water Quality Instruments



## Waterproof and dustproof

IP67 rated waterproof and dustproof casing.  
\*IP67: Fully waterproof for approximately 30 minutes in 1 meter of water.



## Shock-resistant

Polycarbonate resin\* used in automobiles and mobile phones has been adopted to enhance shock resistance.  
\*Polycarbonate resin has about twice the shock resistance of conventional ABS resin.



## Easy to carry

The compact and ergonomic design is easy to carry and includes an electrode hook attachment.

## Electrode holder

Included adaptor allows up to 2 electrodes to be attached on either side of the meter.

## Rugged carry-case

Moulded carry-case houses meter as well as the sensors, calibrating solutions, manuals, batteries. Convenient for field measurement and safe storage place for meter and accessories

## 9651-10D plastic body gel-filled electrode

- pH range 0 to 14
- temp range 0 to 80°C
- Porous sintered polyethylene liquid junction
- With integrated temperature sensor
- Waterproof, Lead-free glass
- 1m cable with BNC & phono jack connectors

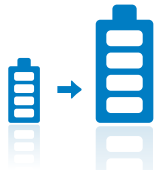

## Extended operation

Uses about 10% of the power compared to conventional meters. With up to 1000 hrs of use, long periods of field work is possible.

CAL MEAS DATA



## One hand operation

Slim body fits in your hand. Only three basic operation buttons for one-hand operability.



## Auto Hold or Auto Stable functions

- In auto hold mode, meter freezes LCD when readings are stable
- Auto stable mode continuously refreshes readings on LCD with stability indicator



## Large LCD Screen

- Large 64mm by 52mm screen allows for clear view of readings, diagnostic messages
- Backlight available in selected models

## Visible LCD in dark places

Backlight allows reading of measured values even in the dark.

## Dual-display screen (pH 130, PC 110 & PD 110)

- Dual channel meters feature dual display screen
- Simultaneous independent measurements of both channels
- Independent setup for each channel

## TDS calibration curves

TDS models include predetermined standard curves for more accurate TDS readings across the measurement range. For convenience, calibration is only performed in EC mode.

Application	Environmental	Boiler water, HVAC	Aquaculture, pickling
Key chemical species	EN standard for environmental water	Na <sub>2</sub> SO <sub>4</sub> , NaHCO <sub>3</sub> , NaCl	NaCl
TDS selection	EN27888 curve	442 (Myron) curve	NaCl curve

## pH Meters



Model	<b>pH 110</b> pH/ORP/Temp (°C)	<b>pH 120</b> pH/ORP/Temp (°C)	<b>pH 130</b> Dual Channel pH/ORP/Ion/Temp (°C)
Part No.	3200739844	3200739845	3200739846
pH range	-2.00 to 16.00 pH	-2.00 to 16.00 pH	-2.00 to 16.00 pH
Resolution	0.01 pH	0.01 pH	0.01 pH
Accuracy	±0.01 pH	±0.01 pH	±0.01 pH
Cal points	5	5	5
Buffer options	USA, NIST	USA, NIST, Custom	USA, NIST, Custom
ORP range	±2000 mV	±2000 mV	±2000 mV
Resolution	1 mV	1 mV	1 mV
Accuracy	1 mV or 1% of reading (whichever is greater)	1 mV or 1% of reading (whichever is greater)	1 mV or 0.2% of reading (whichever is greater)
Ion range	—	—	0.00 µg/l to 999 g/l
Resolution	—	—	3 significant digits
Accuracy	—	—	±0.8% full scale
Cal points	—	—	Up to 5
Temperature range	-30.0 °C to 130 °C	-30.0 °C to 130 °C	-30.0 °C to 130 °C
Resolution	0.1 °C	0.1 °C	0.1 °C
Accuracy	±0.4 °C	±0.4 °C	±0.4 °C
Cal option	Yes	Yes	Yes
Memory	150	1000	1000
Data-logging	—	Yes	Yes
Real time clock	—	Yes	Yes
Date/time stamping	—	Yes	Yes
Auto Shut-off	Yes (programmable: 1 to 30 mins)	Yes (programmable: 1 to 30 mins)	Yes (programmable: 1 to 30 mins)
Auto-Hold	Yes	Yes	Yes
Averaging/Stability	Yes, Automatic	Yes, Automatic	Yes, Automatic
Offset display	Yes	Yes	Yes
Slope display	Yes (independent acid and alkaline slopes depending on calibration)	Yes (independent acid and alkaline slopes depending on calibration)	Yes (independent acid and alkaline slopes depending on calibration)
Cal Alarm	Yes (programmable: 1 to 400 days)	Yes (programmable: 1 to 400 days)	Yes (programmable: 1 to 400 days)
Electrode status	On screen display	On screen display	On screen display
Diagnostic messages	Yes	Yes	Yes
Display	Custom LCD	Custom LCD with backlight	Custom LCD with backlight
Inputs	BNC, phono, DC sockets	BNC, phono, DC sockets	2 x BNC, 2 x phono, DC sockets
Outputs	—	RS232C	RS232C
IP rating	IP67, shock resistant	IP67, shock resistant	IP67, shock resistant
Power requirements	2 x 'AAA' or LR03 or Ni-H rechargeable batteries or power adaptor	2 x 'AAA' or LR03 or Ni-H rechargeable batteries or power adaptor	2 x 'AAA' or LR03 or Ni-H rechargeable batteries or power adaptor
Battery life	> 1000 hrs	> 1000 hrs	> 500 hrs
Kit* includes:	PH110-K Waterproof pH/ORP handheld meter (Part No. 3999960167) <ul style="list-style-type: none"> <li>• PH110 meter</li> <li>• 9651-10D plastic-body, gel-filled pH electrode</li> <li>• pH 4.01, 7.00, 10.01 solutions (60ml)</li> <li>• carry case</li> </ul>	PH120-K Waterproof pH/ORP handheld data meter (Part No. 3999960168) <ul style="list-style-type: none"> <li>• PH120 meter</li> <li>• 9651-10D plastic-body, gel-filled pH electrode</li> <li>• pH 4.01, 7.00, 10.01 solutions (60ml)</li> <li>• carry case</li> </ul>	PH130-K Waterproof pH/ORP/Ion handheld data meter (Part No. 3999960169) <ul style="list-style-type: none"> <li>• PH130 meter</li> <li>• 9651-10D plastic-body, gel-filled pH electrode</li> <li>• pH 4.01, 7.00, 10.01 solutions (60ml)</li> <li>• carry case</li> </ul>

\*Kit with NIST buffers set is available upon request. Add 'N' suffix to order code when ordering

## Conductivity Meters



Model	EC 110	EC 120
Part No.	3200739842	3200739847
EC range	.. μS/cm to 200.0 mS/cm (@ k=1.0)	.. μS/cm to 200.0 mS/cm (@ k=1.0)
Resolution	0.05% F.S.	0.05% F.S.
Accuracy	±0.6% F.S.; ±1.5% F.S. > 18.0 mS/cm	±0.6% F.S.; ±1.5% F.S. > 18.0 mS/cm
Ref. temp.	15 to 30 °C (adjustable)	15 to 30 °C (adjustable)
Temp. compensation	0.0 to 10.0% (adjustable)	0.0 to 10.0% (adjustable)
Cell constants	0.1 / 1.0 / 10.0	0.1 / 1.0 / 10.0
Cal points	4 points	4 points
Units setting	Auto ranging / Manual μS/cm or mS/cm or S/m	Auto ranging / Manual μS/cm or mS/cm or S/m
TDS range	... ppm to 100 ppt (TDS factor @ 0.5)	... ppm to 100 ppt (TDS factor @ 0.5)
Resolution	0.01ppm / 0.1 ppt	0.01ppm / 0.1 ppt
Accuracy	±0.1% F.S.	±0.1% F.S.
TDS curves	EN27888, 442, linear (0.40 to 1.0)	EN27888, 442, linear (0.40 to 1.0)
Resistivity Range	0.000 Ω/cm to 200.0 MΩ/cm	0.000 Ω/cm to 200.0 MΩ/cm
Resolution	0.05% F.S.	0.05% F.S.
Accuracy	0.6% F.S. ±1.5% F.S. > 1.80 MΩ/cm	0.6% F.S. ±1.5% F.S. > 1.80 MΩ/cm
Salinity	—	0.0 to 100.0 ppt 0.00 to 10.00 %
Resolution	—	0.1 ppt / 0.1%
Accuracy	—	0.2% F.S.
Cal curves	—	NaCl / Sea water
Temperature range	-30.0 °C to 130 °C	-30.0 °C to 130 °C
Resolution	0.1 °C	0.1 °C
Accuracy	±0.4 °C	±0.4 °C
Memory	100	1000
Data-logging	—	Yes
Real time clock	—	Yes
Date/time stamping	—	Yes
Auto Shut-off	Yes (programmable: 1 to 30 mins)	Yes (programmable: 1 to 30 mins)
Auto-Hold	Yes	Yes
Diagnostic messages	Yes	Yes
Display	Custom LCD	Custom LCD with backlight
Inputs	BNC, phono, DC sockets	BNC, phono, DC sockets
Outputs	—	RS232C
IP rating	IP67, shock resistant	IP67, shock resistant
Power requirements	2 x 'AAA' or LR03 or Ni-H rechargeable batteries or power adaptor	2 x 'AAA' or LR03 or Ni-H rechargeable batteries or power adaptor
Battery life	> 200 hrs	> 200 hrs
Kit includes:	EC110-K Waterproof EC/TDS/Res handheld meter (Part No. 3999960170) • EC110 meter • 9382-10D plastic-body, Titanium/Platinum black, conductivity cell, k=1.0 • 84uS/cm, 1413 uS/cm, 12.88 mS/cm solutions (60ml) • carry case	EC120-K Waterproof EC/TDS/Res/Sal handheld data meter (Part No. 3999960171) • EC120 meter • 9382-10D plastic-body, Titanium/Platinum black, conductivity cell, k=1.0 • 84uS/cm, 1413 uS/cm, 12.88 mS/cm, 111.8 mS/cm solutions (60ml) • carry case

## Dissolved Oxygen Meters



Model	<b>DO 110</b>	<b>DO 120</b>
	DO / Temp (°C)	DO / Temp (°C)
Part No.	3200739848	3200739849
Dissolved Oxygen range	0.0 to 20.00 mg/l 0.0 to 200.0%	0.0 to 20.00 mg/l 0.0 to 200.0%
Resolution	0.01 mg/l or 0.1%	0.01 mg/l or 0.1%
Accuracy	±0.1 mg/l	±0.1 mg/l
Salinity compensation	0 to 40 ppt	0 to 40 ppt
Barometric pressure compensation	Yes	Yes
DO Probe type	Galvanic with integrated temperature sensor	Galvanic with integrated temperature sensor
Calibration	1 or 2 points	1 or 2 points

Temperature range	-30.0 °C to 130 °C	-30.0 °C to 130 °C
Resolution	0.1 °C	0.1 °C
Accuracy	±0.4 °C	±0.4 °C

Memory	100	1000
Data-logging	—	Yes
Real time clock	—	Yes
Date/time stamping	—	Yes
Auto Shut-off	Yes (programmable: 1 to 30 mins)	Yes (programmable: 1 to 30 mins)
Auto-Hold	Yes	Yes
Diagnostic messages	Yes	Yes
Display	Custom LCD	Custom LCD with backlight
Inputs	BNC, phono, DC sockets	BNC, phono, DC sockets
Outputs	—	RS232C
IP rating	IP67, shock resistant	IP67, shock resistant
Power requirements	2 x 'AAA' or LR03 or Ni-H rechargeable batteries or power adaptor	2 x 'AAA' or LR03 or Ni-H rechargeable batteries or power adaptor
Battery life	> 500 hrs	> 500 hrs

Kit includes:	DO110-K Waterproof Dissolved Oxygen meter (Part No. 3999960172) • DO110 meter • 9551-20D Galvanic DO probe, 2m cable • carry case	DO120-K Waterproof Dissolved Oxygen data meter (Part No. 3999960173) • DO120 meter • 9551-20D Galvanic DO probe, 2m cable • carry case
---------------	---	--

# Multi-Parameter Meters



Models	PC 110 Dual Channel pH/ORP/ EC/TDS/Res/Sal/Temp (°C)	PD 110 Dual Channel pH/ORP/ DO/Temp (°C)
Part No.	3200739850	3200739843
pH range	-2.00 to 16.00 pH	-2.00 to 16.00 pH
Resolution	0.01 pH	0.01 pH
Accuracy	±0.01 pH	±0.01 pH
Cal points	5	5
Buffer options	USA, NIST	USA, NIST
ORP range	±2000 mV	±2000 mV
Resolution	1 mV	1 mV
Accuracy	1 mV or 1% of reading (whichever is greater)	1 mV or 1% of reading (whichever is greater)
Dissolved Oxygen range	—	0.0 to 20.00 mg/l 0.0 to 200.0%
Resolution	—	0.01 mg/l or 0.1%
Accuracy	—	±0.1 mg/l
Salinity compensation	—	0 to 40 ppt
Barometric pressure compensation	—	Yes
DO Probe type	—	Galvanic with integrated temperature sensor
Calibration	—	1 or 2 points
EC range	... µS/cm to 200.0 mS/cm (@ k=1.0)	—
Resolution	0.05% F.S.	—
Accuracy	±0.6% F.S.; ±1.5% F.S. > 18.0 mS/cm	—
Ref. temp.	15 to 30 °C (adjustable)	—
Temp. compensation	0.0 to 10.0% (adjustable)	—
Cell constants	0.1 / 1.0 / 10.0	—
Cal points	4 points	—
Units setting	Auto ranging / Manual µS/cm or mS/cm or S/m	—
TDS range	... ppm to 100 ppt (TDS factor @ 0.5)	—
Resolution	0.01ppm / 0.1 ppt	—
Accuracy	±0.1% F.S.	—
TDS curves	EN27888, 442, linear (0.40 to 1.0)	—
Resistivity Range	0.000 Ω/cm to 200.0 MΩ/cm	—
Resolution	0.05% F.S.	—
Accuracy	0.6% F.S. ±1.5% F.S. > 1.80 MΩ/cm	—
Salinity	0.0 to 100.0 ppt 0.00 to 10.00 ‰	—
Resolution	0.1 ppt / 0.1%	—
Accuracy	0.2% F.S.	—
Cal curves	NaCl / Sea water	—
Memory	1000	1000
Data-logging	Yes	Yes
Real time clock	Yes	Yes
Date/time stamping	Yes	Yes
Auto Shut-off	Yes (programmable: 1 to 30 mins)	Yes (programmable: 1 to 30 mins)
Auto-Hold	Yes	Yes
Averaging/Stability	Yes, Automatic	Yes, Automatic
Offset display	Yes	Yes
Slope display	Yes (independent acid and alkaline slopes depending on calibration)	Yes (independent acid and alkaline slopes depending on calibration)
Cal Alarm	Yes (programmable: 1 to 400 days)	Yes (programmable: 1 to 400 days)
Electrode status	On screen display	On screen display
Diagnostic messages	Yes	Yes
Display	Custom LCD with backlight, Dual channel	Custom LCD with backlight, Dual channel
Inputs	Dual BNC, phono, DC sockets	Dual BNC, phono, DC sockets
Outputs	RS232C	RS232C
IP rating	IP67, shock resistant	IP67, shock resistant
Power requirements	2 x 'AAA' or LR03 or Ni-H rechargeable batteries or power adaptor	2 x 'AAA' or LR03 or Ni-H rechargeable batteries or power adaptor
Battery life	> 200 hrs	> 500 hrs

Kit* includes:	PC110-K Waterproof pH/ORP/EC/TDS/Res/Sal handheld data meter (Part No. 3999960174) <ul style="list-style-type: none"> <li>• PC110 meter</li> <li>• 9651-10D plastic gel-filled pH electrode</li> <li>• 9382-10D plastic-body, Titanium/Platinum black, conductivity cell, k=1.0</li> <li>• pH 4.01, pH7.00, 1413 uS/cm, 12.88 mS/cm solutions (60ml)</li> <li>• carry case</li> </ul>	PD110-K Waterproof pH/ORP/DO handheld data meter (Part No. 3999960175) <ul style="list-style-type: none"> <li>• PD110 meter</li> <li>• 9651-10D plastic gel-filled pH electrode</li> <li>• 9551-20D Galvanic DO probe, 2m cable</li> <li>• pH 4.01, 7.00, 10.01 solutions (60ml)</li> <li>• carry case</li> </ul>
----------------	---	---

\*Kit with NIST buffers set is available upon request. Add 'N' suffix to order code when ordering

## pH Solutions

Name	Type	Specification	Volume	Part No.
Buffer Solution at 25°C	100-2	pH 1.68	500ml	3200043639
	100-4	pH 4.01	500ml	3200043638
	100-7	pH 6.86	500ml	3200043637
	100-7U	pH 7.00 (USA)	500ml	3200738711
	100-9	pH 9.18	500ml	3200043636
	100-10U	pH 10.01 (USA)	500ml	3200738712
	12.46	Available on request	500ml	-



## Conductivity Solutions

Name	Type	Specification	Volume	Part No.
Conductivity Standard Solution at 25°C	100-21	84 uS	500ml	3200738713
	100-22	1413 uS	500ml	3200738714
	100-23	12.88 mS	500ml	3200738715
	100-24	111.8 mS	500ml	3200738716

## Electrode Internal Solution

- For electrode maintenance of refillable pH, ORP, and reference electrodes.

Name	Type	Volume (ml)	Part No.
Internal Solution	300	250	3200043640

## ORP Powder

Name	Type	Specification	Packet	Part No.
Powder for ORP Standard Solution 	160-51	89 mV For 250 ml	10	3200043618
	160-22	258 mV For 250 ml	10	3200043617

## Electrode Cleaning Solutions

- For removing inorganic sample residues from glass electrodes, and for cleaning liquid junctions.

Name	Type	Volume (ml)	Part No.
Cleaning Solution 	220	50 x 2 pcs	3014028653

## Accessories

Name	Description	Part No.
CBM-910 Printer	US version 120V Serial Printer	5700012747
AC adapter cable set	Multi-voltage (100-240V) with USA 120V cable	3200647413
Digital simulator X-51	pH, mV, Ion, DO simulator	3014028368
Digital simulator X-52	Conductivity simulator	3014028370
Serial cable	Cable to connect meter and PC (Serial, 9 pins)	3014030151
Electrode hook	With function for winding the cable	3200528475
DP-70S Electrode stand (adjustable type)	With holder for D/ES/OM-70	3200528474

- For removing protein containing sample residues from glass electrodes, and for cleaning liquid junctions.

Name	Type	Volume (ml)	Part No.
Cleaning Solution	250	400	3200366771

## Electrodes

Name	Description	Part No.
9651-10D	Plastic-body, gel-filled pH electrode with integrated temperature sensor	3200642020
9382-10D	Plastic-body, k=1.0 conductivity cell, Titanium / Platinum black, with integrated temperature sensor	3014046709
9551-20D	Immersible DO probe with integrated temperature sensor and 2m cable	3014047090
9300-10D	Platinum Electrode for ORP measurement	3014046710



Printer (for GLP/GMP compliance)



Digital simulator

Dimensions Unit: mm

100 Series / D-70 Series /  
ES-70 Series / OM-70 Series

Electrode Stand (DP-70S)

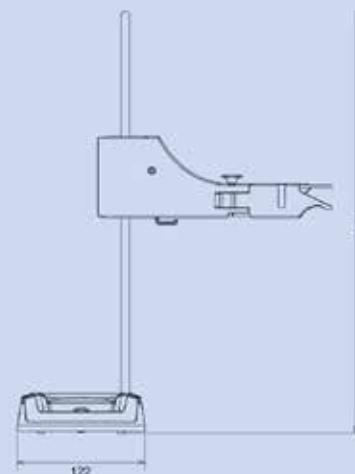
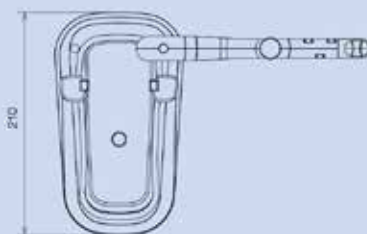
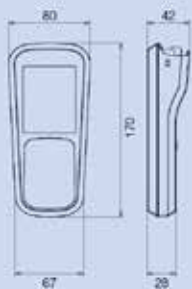

With over 60 years of engineering excellence, HORIBA's diverse range of water quality analyzers and electrodes are ideal for everyday laboratory needs through to the most demanding of applications. Visit our website for a wealth of useful information and water quality measurement tips to help you obtain the best results in your work.



### Electrodes

HORIBA's superior electrode technology has been employed in manufacturing our unparalleled tough pH glass bulbs and unique flat sensors. Our electrodes have different designs to cater a wide range of applications—from pure water to complex samples. Select the suitable electrode that is specially designed for your application.



### Bench Meters

Developed using extensive feedback from users, our new LAQUA meters deliver the best solution for water quality analysis. Our LAQUA website features an online 'Selection Guide' to enable you to find the perfect LAQUA meter and electrode for your need.



### Pocket Meters

Analyzing water quality is simplified when using our LAQUAtwin range of meters. Designed to produce accurate and reliable results. Anyone, anywhere, at any time can measure samples easily with a LAQUAtwin meter. See just how good they are at our website.

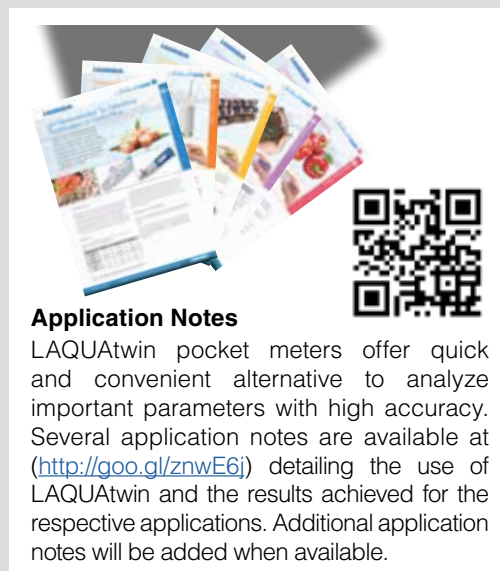

### Application Notes

LAQUAtwin pocket meters offer quick and convenient alternative to analyze important parameters with high accuracy. Several application notes are available at (<http://goo.gl/znwE6j>) detailing the use of LAQUAtwin and the results achieved for the respective applications. Additional application notes will be added when available.

## SUPPORT HORIBA CUSTOMER SUPPORT SYSTEM

HORIBA offers a variety of services to conform to quality standards and international guidelines such as GLP, GMP and ISO

**Technical Support**  
 Please contact us with any technical questions about our products.  
[www.horiba.com/wq/support](http://www.horiba.com/wq/support)

**User Support**  
 Our support website is available for registered customers and features:  
 • Data collection software  
 • Instruction manual downloads  
 • Measurement tips, etc.  
[www.horiba.co.jp/register](http://www.horiba.co.jp/register)

**Validation Support**  
 Please contact us with any questions or requirements for your validation procedure.  
 • Traceability certification\*  
 • IQ/OQ/PQ support\*  
 • SOP guidance  
 • FAQ  
 \*Optional services

 Please read the operation manual before using this product to assure safe and proper handling of the product.

- The contents of this catalog are subject to change without prior notice, and without any subsequent liability to this company.
- The color of the actual products may differ from the color pictured in this catalog due to printing limitations.
- It is strictly forbidden to copy the content of this catalog in part or in full.
- All brand names, product names and service names in this catalog are trademarks or registered trademarks of their respective companies.
- Windows is a registered trademark of Microsoft Corporation in the United States and other countries.
- Complies with all ACMA RCM compliance requirements EMC Systems Doc Number: C160104-2 