



# FGA CALIBRATION INSTRUCTIONS

Rev 1.0 (6/8/2021)



## Tools Required

- a. 5mm hex key
- b. Small insertion tool (paper clip, pin, etc)
- c. Torque analyzer or torque sensor matching desired calibration range

## Calibration Process

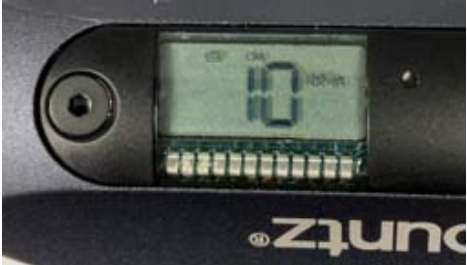
Step		Procedure
1.		Adjust the tool to the maximum torque setting per the display. Apply three (3) torque loadings.
2.		<p>Rotate the adjustment knob counterclockwise as far as it will go to remove all load from the tool.</p> <p>Press the POWER button to turn on the screwdriver. Once the unit is on, use small insertion tool (ie: paperclip) and press on the CALIBRATION button.</p>
3.		<p>The screen will briefly display "CAL" before showing the torque unit selection screen. Press POWER to cycle through the options to reach your desired units, then press CAL again to select.</p> <ul style="list-style-type: none"> <li>Option 1. cN·m (Not available on FGA-80)</li> <li>Option 2. N·m</li> <li>Option 3. lbf·in</li> <li>Option 4. ozf·in (Not available on FGA-80)</li> <li>Option 5. kgf·cm</li> </ul>

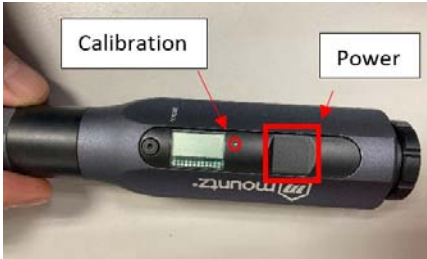
4.		<p>Using the POWER button, cycle through the RANGES until the display reads the value corresponding to your tool MODEL. Then press the CAL button to accept. A breakdown of the models and their display can be found below FGA-8 - 8.00lbf.in</p> <ul style="list-style-type: none"> <li>a. FGA-20 - 20.0 lbf.in</li> <li>b. FGA-40 - 40.0 lbf.in</li> <li>c. FGA-80 - 80.0 lbf.in</li> </ul> <p>Note: This display is only to differentiate the model and the tool will calibrate in the units selected in step 3</p>																																			
5.		<p>The screen will bring up the first point of calibration displayed in the percentage of max setting. The image on the left reads 10%. Calculate TARGET torque based on the displayed percentage.</p> <p>This first percentage will differ depending on which tool model is being calibrated:</p> <ul style="list-style-type: none"> <li>a. FGA 8 – 20%</li> <li>b. FGA 20, FGA 40, FGA 80 – 10%</li> </ul>																																			
6.		<p>Using the torque analyzer or sensor, adjust the tool to the TARGET torque calculated based off of percentages of the max torque shown below. <b>The tool must be set to the target value from a lower setting.</b> If the TARGET is exceeded, the tool must be adjusted below the TARGET and readjusted up.</p> <table border="1" data-bbox="792 1350 1463 1654"> <thead> <tr> <th rowspan="2">Model</th> <th colspan="5">Torque Level % (Calculated percentages shown in lbf.in)</th> </tr> <tr> <th>10%</th> <th>20%</th> <th>30%</th> <th>50%</th> <th>100%</th> </tr> </thead> <tbody> <tr> <td>FGA-8i</td> <td>NA</td> <td>1.6</td> <td>NA</td> <td>4</td> <td>8</td> </tr> <tr> <td>FGA-20i</td> <td>2</td> <td>NA</td> <td>NA</td> <td>10</td> <td>20</td> </tr> <tr> <td>FGA-40i</td> <td>4</td> <td>NA</td> <td>NA</td> <td>20</td> <td>40</td> </tr> <tr> <td>FGA-80i</td> <td>8</td> <td>NA</td> <td>24</td> <td>40</td> <td>80</td> </tr> </tbody> </table>	Model	Torque Level % (Calculated percentages shown in lbf.in)					10%	20%	30%	50%	100%	FGA-8i	NA	1.6	NA	4	8	FGA-20i	2	NA	NA	10	20	FGA-40i	4	NA	NA	20	40	FGA-80i	8	NA	24	40	80
Model	Torque Level % (Calculated percentages shown in lbf.in)																																				
	10%	20%	30%	50%	100%																																
FGA-8i	NA	1.6	NA	4	8																																
FGA-20i	2	NA	NA	10	20																																
FGA-40i	4	NA	NA	20	40																																
FGA-80i	8	NA	24	40	80																																

7.		Using the torque analyzer or sensor apply ten (10) loadings and record all values. All ten of these values must be within $\pm 6\%$ of the TARGET and the average of the recorded values must be within $\pm 2\%$ of the TARGET. If either of these criteria is not met, adjust the tool as necessary and repeat.
8.		Once the above criteria are met, press the POWER button to store the setting to the tool. The number shown in step 5 for the setting will change to a reference number for the potentiometer (this number is for reference only and engineering use) Note: The power button may be pressed several times without any issues if the display does not change immediately Press the CALIBRATION button to advance to the next step.
9.		Repeat steps 5-8 for the remaining torque levels shown in the table in step 6. If calibrating
10.		When all set points are complete, the screen will flash 'don' to signify the calibration procedure is complete. Tool will resume normal function using the new calibration afterward.

### Mountz Calibration and Repair Services

Mountz Inc. features an experienced calibration and repair staff. Our trained technicians can calibrate and repair most any tool. Mountz provides rapid service with quality that you can trust as we offer two state-of-the-art calibration lab and repair facilities that can calibrate up to 20,000 lbf.ft.

### About Mountz

Mountz, The Torque Tool Specialists<sup>®</sup>, has been a leader in the torque tool industry for more than 55 years. Engineered in the Silicon Valley and serving the globe, Mountz focuses on delivering high-quality torque products, services, and solutions to ensure customers can always proceed with confidence. We are committed to forging a safer world through precision and accuracy and by innovating every day.

# FGA BATTERY INSTALLATION INSTRUCTIONS

Rev 1.0 (6/10/2021)

## FGA Battery Kit

The FGA battery kit (# 076606) comes with the battery soldered to the PCB assembly. \*Do not remove the battery from the board.\*



## Removal Process

1. Use a 1.5mm hex key to remove the screw.
2. Remove cover.
3. Remove the old PCB assembly.

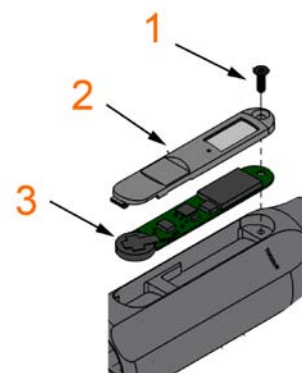

## Installation Process

1. Remove the clear protective cover from the LCD screen.
2. Place the new PCB assembly in the handle.
  - a. Make sure the board lever catches the slot on the upper perch (indicated by the orange arrow in the image to the right).
  - b. You may use the adjustment knob to verify the installation is correct – when the board is powered on and held in place, the display value should change when turning the adjustment knob.
3. Place the cover over the board by first catching the tongue on the cover in the groove on the handle (next to the battery).
4. Apply Loctite® 425™ to the screw. Use a 1.5mm hex key to tighten the screw to 4 lbf-in. Allow a minimum of 20 minutes for Loctite to cure.

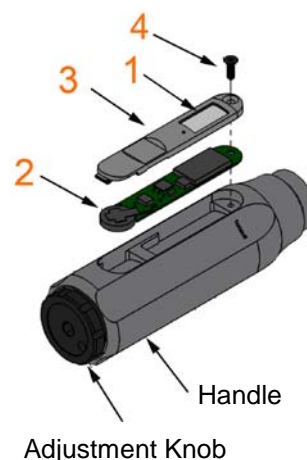
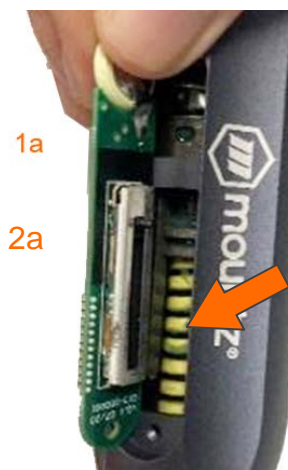

## Calibration

The screwdriver needs to be recalibrated after the battery kit installation.