

Model NS-600 LED Stroboscope



LED Stroboscope Model NS-600

Introduction

Model NS-600 is an enhanced LED, battery operated, stroboscope designed to measure and observe rotating, reciprocating and linear motion in a large variety of production, quality control and academic applications.

- High efficiency LED solid-state light source – never needs replacement
- Extended battery life of 8 hours continuous use at 6,000 fpm/rpm
- Highly stable drift free operation
- Auto wide measuring range – up to 120,000 fpm/rpm
- Push button operation with x2 and ÷2 buttons for quick adjustment
- Store up to 9 flash rates in memory for records or quick retests
- Rugged aluminum housing – compact size
- Easy-to-read 5 digit 0.47" (12 mm) high LCD

Important

Do not look directly at the emitted light.

Instrument is fragile – handle with care.

Do not operate instrument in a humid or dusty environment.

To clean, wipe surface with a damp, soapy cloth. Avoid harsh chemicals.

List of Equipment

- ① NS-600 LED Stroboscope
- ② Carrying case
- ③ 2- AA batteries

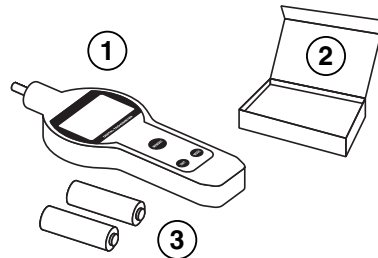

Range (Auto)	Resolution
12.0 ~ 9999.9 fpm/rpm	0.1 fpm/rpm
10000 ~ 120000 fpm/rpm	1 fpm/rpm (over 100,000 display flashes)
.20 ~ 999.00 Hz	0.01 Hz
1000.0 ~ 2000.0 Hz	0.1 Hz

Specifications	
Selectable Units:	FPM or Hz
Accuracy:	±0.01%, ±1 LSD
Display:	12mm high, 5digit LCD
Power:	2- AA batteries
Battery Life:	8 hours (@6,000 rpm when fully charged)
Operating Temp:	0 to 45° C
Weight:	.5 lb/225 g

Dimensions

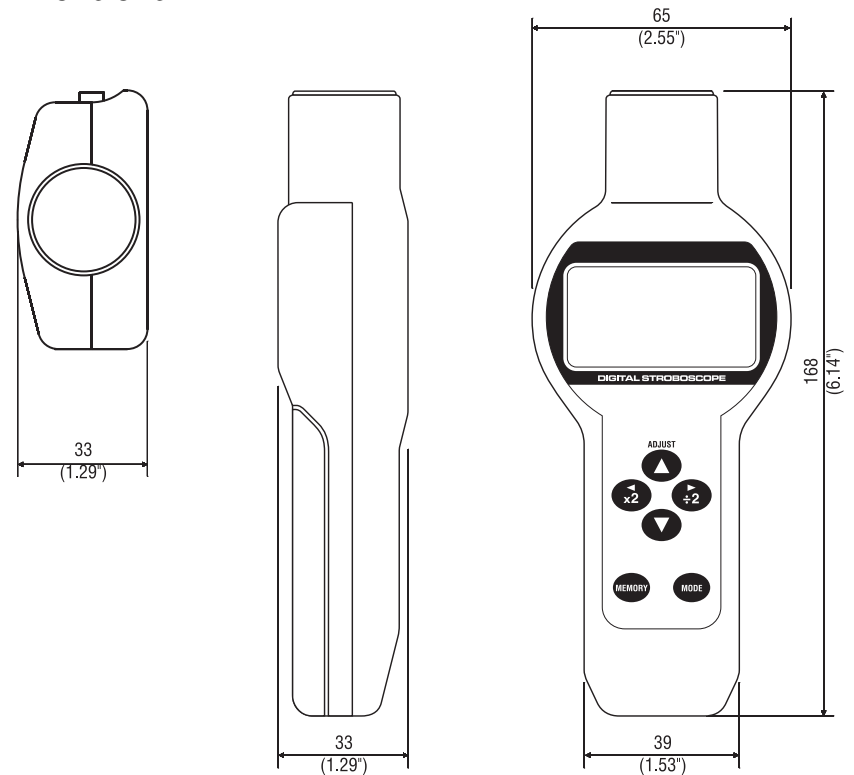

PROGRAM MODE

Changing Units

Turn off the strobe. Press and hold the **MODE** key, then press the **POWER** switch. SEL is displayed. Press the ◀ or ▶ arrows to select FPM or Hz. The selected unit becomes the default when the strobe is powered on. FPM is the default. Press the **POWER** switch to exit.



SELECT WITH LEFT AND RIGHT ARROWS

Changing Flash Duration Default

F0 is the default, good for most applications. To change, turn off the strobe. Press and hold the **MODE** key, then press the **POWER** switch. SEL is displayed, then press the ▲ or ▼ arrows to select F0, F1, F2, ... F6. The selected flash duration level becomes the default when the strobe is powered on. Press the **POWER** switch to exit.

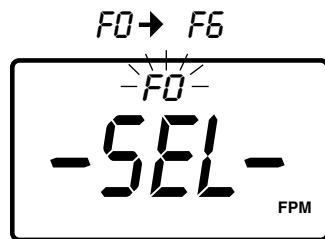

SELECT WITH UP AND DOWN ARROWS

Clearing All Memory

Turn off the strobe. Press and hold the **MODE** key, and then press the **POWER** switch. SEL is displayed. Press and hold **MODE**, then press **MEMORY** to display CLr. Press **MEMORY** again and stored memory is cleared (CLr disappears after three seconds). After memory is cleared the strobe returns to measuring mode.

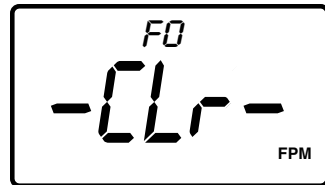

PRESS MEMORY TO CLEAR

LOW BATTERY

When **LOW BATT** appears on the display, turn off the strobe. Loosen the coin screw in the back cover and replace all batteries with the same brand and type. For best performance always replace both batteries together and use AA alkaline, NiMH or NiCAD cells. Please note polarity. Memory is retained even if the batteries are removed.

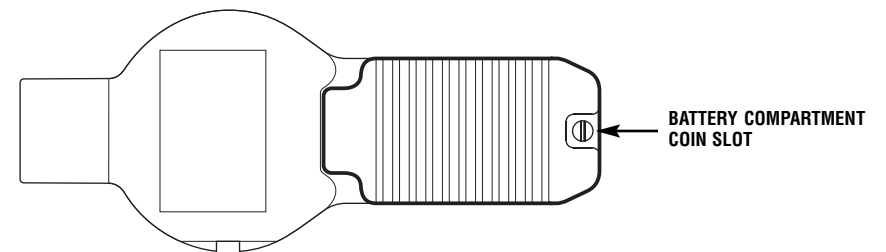
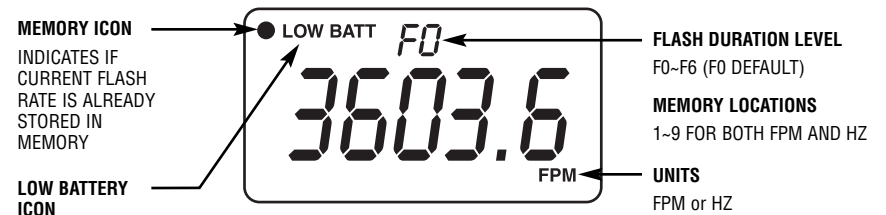
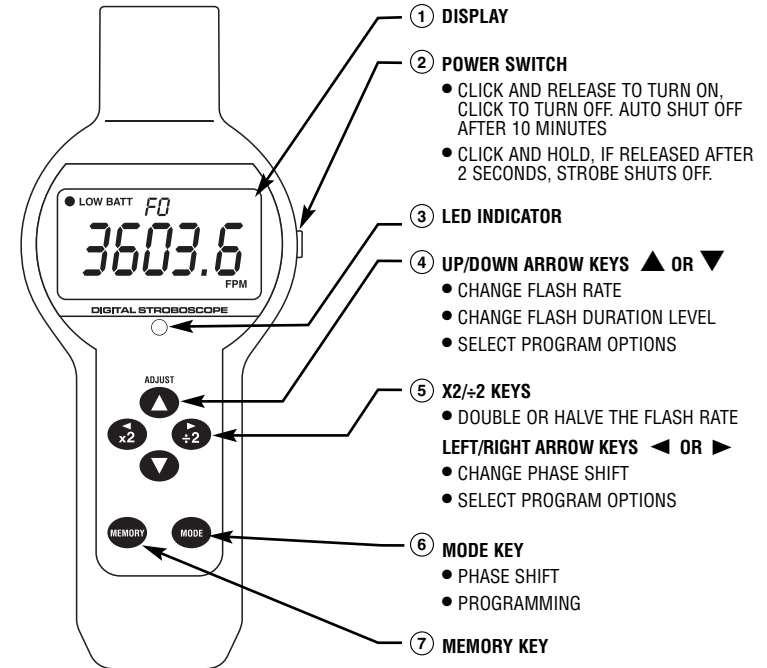
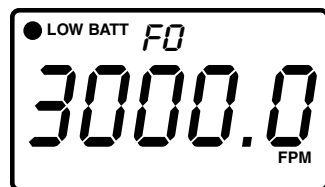

PREPARATION

Remove the battery compartment coin screw and install 2 AA batteries, note the polarity.

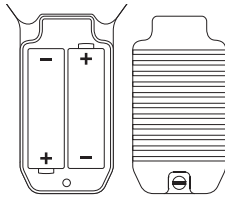

MEASURING

1. Visually note a unique feature or physically mark the object to be measured with reflective tape or a chalk mark.
2. Click the **POWER** switch and release. The LED indicator blinks and the strobe flashes at 3,000 FPM (factory default) or previous power down value. Click to turn off. The strobe automatically shuts off after 10 minutes. Turn on the strobe by clicking and holding the **POWER** switch. If released after two seconds the strobe shuts off.
3. Set flash rate to maximum and aim the NS-600 at the object. To find true rpm, lower the flash rate until the first time a single mark appears. Use **▲** or **▼** arrows to adjust the flash rate until the feature or mark appears frozen. The flash rate changes more rapidly the longer the **▲** or **▼** arrow key is held, then resets 1.5 seconds after it is released.

*Advanced users: After releasing the **▲** or **▼** arrow, the numeric place of the flashing digit indicates the rate of change. Press the **▲** or **▼** arrows to change the value of the flashing digit. While a digit is flashing, press the **◀** or **▶** arrows to move the numeric place of the flashing digit higher or lower. Then press the **▲** or **▼** arrow to change the flash rate using that increment.*

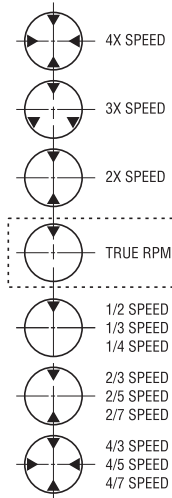

Note: If the flash rate is 1/2 of true rpm, 1/3, 1/4, etc., a single mark also appears. If the flash rate is 2x true rpm, two marks appear, 3x true rpm, three marks, 4x, four marks, etc. If the flash rate is 2/3 of true rpm, 2/5, 2/7 etc., two marks appear. And 4/3, 4/5 and 4/7 four marks appear, etc.

Digital Phase Shift (image rotation)

After synchronizing the flash rate with the rotating object, press and hold the **MODE** key while pressing the **◀** or **▶** arrows to adjust the angle. When the strobe is turned off, the phase shift setting resets to zero.

Changing Flash Duration (increasing sharpness)

Flash duration is set at F0, which is suitable for most applications. However, images can be sharpened by decreasing flash duration.

After synchronizing the flash rate with the moving object, press and hold the **MODE** key, then press the **▲** or **▼** arrows to select levels F0, F1, F2, ... F6. As flash duration shortens the image gets sharper and less bright. Longer flash durations are brighter and less sharp.

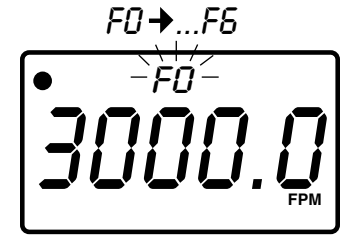

SELECT WITH UP AND DOWN ARROWS

The display is retained for two minutes after the strobe is powered off. If turned back on while the display is on, the strobe returns to the flash rate shown on the display. The strobe powers off after five minutes of non-use.

MEMORY (FPM and Hz units each have nine separate memory locations)

Saving Flash Rates in Memory

Turn on the strobe and synchronize the flash rate with the moving object. Press and hold **MODE**, then press **MEMORY**, a memory location number appears briefly and the flash rate is saved to that memory location. When nine locations have been saved FUL appears on the display.

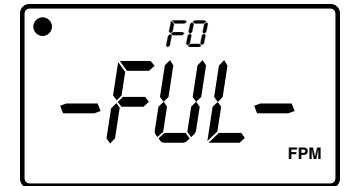

Memory Recall

Press **MEMORY** to enter memory mode and memory location '1' appears at the top of the display. Press **MEMORY** again to select another location. If no flash rates are stored, numbers do not appear.

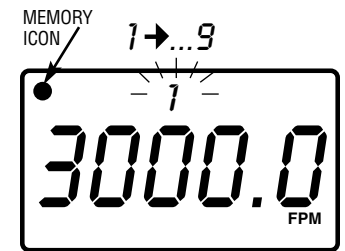

PRESS MEMORY TO CHANGE LOCATION

Changing Memory Values

Select a memory location (see Memory Recall above). The memory icon indicates the stored flash rate matches the current flash rate. Use the arrow keys to change the flash rate (the memory icon disappears). To save the new flash rate, press and hold **MODE**, then press **MEMORY**. The memory icon reappears and shows that the current flash rate is stored.

Clearing All Memory (see page 6)